

Ø 20-200 mm



SYSTEM **KAN-therm**

PP Green

High quality
for reasonable price

EN 2018



TECHNOLOGY OF SUCCESS



ISO 9001

Index

1	System KAN-therm PP Green	
	The material	4
	Sanitary systems installation	5
	Pipes	5
	Thermal elongation	9
	Compensators	10
	„L”, „Z”, and „U” compensator selection	10
	Connection technique - socket fusion welding (20-125 mm)	12
	Installation of pipe saddle fittings PP Green	13
	Connection technique - electrofusion welding (20-200 mm)	14
	Tools - safety	15
	Installation procedures	15
	Pressure testing	17
	Service life of KAN-therm PP Green system	18
	Application areas	19
	Handling and storage	20
	System KAN-therm PP - assortment	21
	Tools	31

This commercial information is binding as of May 1st, 2018.

From the date this information is published information concerning same matter is no longer in force.

KAN reserves the right to complement this information, to change it or replace it by any other commercial information at any time.

© Copyright **KAN** All rights reserved. The text, graphics, and the graphical outlay in **KAN** publications are protected by copyright.



1 System **KAN-therm** PP Green

System KAN-therm PP Green is a complete installation system consisting of pipes and fittings made of polypropylene.

The system is widely used in construction, particularly in water supply systems.

The elements of the system are connected by welding (thermal polyfusion) with the use of electric welders. Welding technique through a homogeneous combination provides outstanding tightness and mechanical strength of the installation.

The material

The plastic used in the production of pipes and fittings of the System KAN-therm PP Green is the high quality alpha type random polypropylene copolymer (PP-R) which used to be marked as Type 3.

In diameter range above 110 mm, pipes are made of beta type random polypropylene copolymer (PP-RCT) which used to be marked as Type 4.

System KAN-therm PP Green is characterised by a number of advantages:

- high microbiological and physiological inertness of products
- high chemical resistance,
- resistance to material corrosion,
- low thermal conductivity,
- low specific mass,
- resistance to scale accumulation,
- dampening of flow vibrations and noises,
- mechanical strength,
- homogeneity of connections,
- high operation durability.



The scope of uses

The installation System KAN-therm PP Green, due to its material properties, has a wide range of use:

- cold (20°C/1.0 MPa) and hot (60°C/1.0 MPa) water in residential buildings in hospitals, hotels, office buildings, schools,
- central heating systems (temp. up to 90°C, working pressure up to 0.6 MPa),
- compressed air systems,
- balneological installations,
- installations in agriculture and gardening,
- industrial pipelines, e.g. for transporting of aggressive media and food substances,
- naval installations.

The scope of applications includes new installations, as well as repairs, modernizations and replacements.

Sanitary systems installation

System KAN-therm PP Green installations, thanks to the special properties of PP-R polypropylene (physiological and microbiological inertness, resistance to corrosion, to scale accumulation, vibration resistance, high thermal insulation of pipes), they are widely used especially in water supply systems, in particular in the installation of risers and horizontal pipes.

This refers to both cold and hot water installations - in residential buildings, hospitals, hotels, office buildings, schools, on ships, etc. System KAN-therm PP Green installations are indispensable in the replacement of old, corroded water supply installations.

Due to the specific technique of connection, thermal polyfusion, i.e. welding, tightness and durability of the installation is guaranteed.

Elements of the system

System KAN-therm PP Green includes the following elements:

- PP-R pipes (uniform and compound) supplied in straight sections,
- PP-RCT pipes supplied in straight sections,
- uniform PP-R fittings,
- „adaptor“ couplings with brass threaded inserts,
- sleeves for flange connections, pipe joint connections,
- expansion loops, wallplates, valves,
- fixing elements,
- tools for cutting, machining and welding.

Pipes

Pipe types

System KAN-therm PP Green features four pipe types which differ in wall thickness and structure (compound pipes):

- uniform pipes SDR11 (20 –110 mm),
- uniform pipes SDR7,4 (20 –110 mm),
- uniform pipes SDR6 (20 –110 mm),
- compound pipes SDR7,4 Stabi Al (20 –75 mm),
- compound pipes SDR6 Stabi Al (20 –110 mm),
- compound pipes SDR7,4 Glass (20-110 mm),
- compound pipes SDR6 Glass (20-110 mm)
- compound PP-RCT Glass pipes (125-200 mm).

Pipe series (S), dimension ratio (SDR) and pressure classification (PN) of PP-R pipes

$$S = (D-s)/2s$$

$$SDR = D/s$$

S – pipe dimension series in accordance with ISO 4065

SDR – standard dimension ratio

D – nominal external tube diameter

s – nominal tube wall thickness

PN – pressure nominal

S	SDR	PN
5	11	10
3,2	7,4	16
2,5	6	20

Uniform pipes SDR11						
Dimensions	Ext. diameter D	Wall thick s	Int. diameter d	Unit volume	Unit mass	
[mm]	[mm]	[mm]	[mm]	[l/m]	[kg/m]	
20 × 1,9	20	1,9	16,2	0,206	0,107	Uniform, thin-walled pipes, for cold water. Diameter range from 20×1,9 to 110×10,0 mm. Used in installations: cold utility water, with the operating pressure of 10 bar and calculation temperature of 20°C. 4 m sections.
25 × 2,3	25	2,3	20,4	0,327	0,164	
32 × 2,9	32	2,9	26,2	0,531	0,267	
40 × 3,7	40	3,7	32,6	0,834	0,412	
50 × 4,6	50	4,6	40,8	1,307	0,638	
63 × 5,8	63	5,8	51,4	2,075	1,010	
75 × 6,8	75	6,8	61,4	2,941	1,420	
90 × 8,2	90	8,2	73,6	4,254	2,030	
110 × 10,0	110	10,0	90,0	6,362	3,010	

Uniform pipes SDR7,4						
Dimensions	Ext. diameter D	Wall thick s	Int. diameter d	Unit volume	Unit mass	
[mm]	[mm]	[mm]	[mm]	[l/m]	[kg/m]	
20 × 2,8	20	2,8	14,4	0,163	0,148	Uniform pipes. Diameter range from 20×2,8 mm to 110×15,1 mm. Used in installations: cold and hot utility water, with the operating pressure of 8 bar and calculation temperature of up to 60°C. 4 m sections.
25 × 3,5	25	3,5	18,0	0,254	0,230	
32 × 4,4	32	4,4	23,2	0,415	0,370	
40 × 5,5	40	5,5	29,0	0,615	0,575	
50 × 6,9	50	6,9	36,2	1,029	0,896	
63 × 8,6	63	8,6	45,8	1,633	1,410	
75 × 10,3	75	10,3	54,4	2,307	2,010	
90 × 12,3	90	12,3	65,4	3,358	2,870	
110 × 15,1	110	15,1	79,8	4,999	4,300	

Uniform pipes SDR6						
Dimensions	Ext. diameter D	Wall thick s	Int. diameter d	Unit volume	Unit mass	
[mm]	[mm]	[mm]	[mm]	[l/m]	[kg/m]	
20 × 3,4	20	3,4	13,2	0,137	0,172	Uniform, thick-walled, universal pipes. Diameter range from 20×3,4 to 110×18,4 mm. Used in installations: cold and hot utility water, with the operating pressure of 10 bar and calculation temperature of up to 60°C, and in heating systems (6 bar/80°C, T _{max} =90°C). 4 m sections.
25 × 4,2	25	4,2	16,6	0,216	0,266	
32 × 5,4	32	5,4	21,2	0,353	0,434	
40 × 6,7	40	6,7	26,6	0,556	0,671	
50 × 8,3	50	8,3	33,4	0,866	1,050	
63 × 10,5	63	10,5	42,0	1,385	1,650	
75 × 12,5	75	12,5	50,0	1,963	2,340	
90 × 15,0	90	15,0	60,0	2,827	3,360	
110 × 18,3	110	18,3	73,4	4,208	5,040	

Compound pipes SDR7,4 Stabi Al						
Dimensions	Ext. diameter D	Wall thick s	Int. diameter d	Unit volume	Unit mass	
[mm]	[mm]	[mm]	[mm]	[l/m]	[kg/m]	
20×2,8	20 (21,7)*	2,8	14,4	0,163	0,194	Compound pipes, stabilize, protected by Al foil. Diameter range from 20×2,8 to 75×10,3 mm. Used in installations: cold and hot utility water, with the operating pressure of 10 bar and calculation temperature of up to 60°C, and in heating systems (6 bar/80°C, T _{max} =90°C). 4 m sections * external outer diameter of the tube with Al foil and protection layer
25×3,5	25 (26,7)*	3,5	18	0,254	0,292	
32×4,4	32 (33,7)*	4,4	23,2	0,415	0,462	
40×5,5	40 (41,6)*	5,5	29	0,615	0,682	
50×6,9	50 (51,6)*	6,9	36,2	1,029	1,003	
63×8,6	63 (64,5)*	8,6	45,8	1,633	1,540	
75×10,3	75 (76,5)*	10,3	54,4	2,307	2,590	

Compound pipes SDR6 Stabi Al						
Dimensions	Ext. diameter D	Wall thick s	Int. diameter d	Unit volume	Unit mass	
[mm]	[mm]	[mm]	[mm]	[l/m]	[kg/m]	
20 × 3,4	20 (21,8)*	3,4	13,2	0,137	0,218	Compound, stabilized pipes, reinforced with aluminium film. Diameter range from 20×3,4 to 110×15,1 mm. Used in installations: hot utility water, with the operating pressure of 10 bar and calculation temperature of up to 60°C, and in heating systems (6 bar/80°C, T _{max} =90°C). 4 m sections. * in brackets: internal diameter of the pipe with Al film and protective layer
25 × 4,2	25 (26,9)*	4,2	16,6	0,216	0,328	
32 × 5,4	32 (33,9)*	5,4	21,2	0,353	0,520	
40 × 6,7	40 (41,9)*	6,7	26,6	0,556	0,770	
50 × 8,3	50 (51,9)*	8,3	33,4	0,866	1,159	
63 × 10,5	63 (64,9)*	10,5	42,0	1,385	1,770	
75 × 12,5	75 (76,9)*	12,5	50,0	1,963	2,780	
90 × 15,0	90 (92)*	15,0	60,0	2,830	3,590	
110 × 18,3	110 (112)*	18,3	73,4	4,210	5,340	

Compound pipes SDR7,4 Glass						
Dimensions	Ext. diameter D	Wall thick s	Int. diameter d	Unit volume	Unit mass	
[mm]	[mm]	[mm]	[mm]	[l/m]	[kg/m]	
20 × 2,8	20	2,8	14,4	0,163	0,160	Compound, glass fibre reinforced pipes. Diameter range from 20×2,8 to 110×15,1 mm. Used in installations: hot utility water, with the operating pressure of 10 bar and operating temperature of up to 60°C, and in heating systems (6 bar/80°C, T _{max} =90°C). 4 m sections.
25 × 3,5	25	3,5	18,0	0,254	0,250	
32 × 4,4	32	4,4	23,2	0,415	0,430	
40 × 5,5	40	5,5	29,0	0,615	0,650	
50 × 6,9	50	6,9	36,2	1,029	1,000	
63 × 8,6	63	8,6	45,8	1,633	1,520	
75 × 10,3	75	10,3	54,4	2,307	2,200	
90 × 12,3	90	12,3	65,4	3,358	3,110	
110 × 15,1	110	15,1	79,8	4,999	4,610	

Compound pipes SDR6 Glass						
Dimensions	Ext. diameter D	Wall thick s	Int. diameter d	Unit volume	Unit mass	
[mm]	[mm]	[mm]	[mm]	[l/m]	[kg/m]	
20 × 3,4	20	3,4	13,2	0,137	0,180	Compound, glass fibre reinforced pipes. Diameter range from 20×3,4 to 110×18,4 mm. Used in installations: hot utility water, with the operating pressure of 10 bar and operating temperature of up to 60°C, and in heating systems (6 bar/80°C, T _{max} =90°C). 4 m sections.
25 × 4,2	25	4,2	16,6	0,216	0,290	
32 × 5,4	32	5,4	21,2	0,353	0,460	
40 × 6,7	40	6,7	26,6	0,556	0,680	
50 × 8,3	50	8,3	33,4	0,866	1,000	
63 × 10,5	63	10,5	42,0	1,385	1,550	
75 × 12,5	75	12,5	50,0	1,963	2,340	
90 × 15,0	90	15,0	60,0	2,827	3,360	
110 × 18,3	110	18,3	73,4	4,208	4,900	

Compound pipes PP-RCT Glass SDR9 and SDR11

Dimensions	Ext. diameter D	Wall thick s	Int. diameter d	Unit volume	Unit mass
[mm]	[mm]	[mm]	[mm]	[l/m]	[kg/m]
125 × 14,0	140	14,0	97,0	12,270	4,480
160 × 14,6	160	14,6	130,8	20,100	6,780
200 × 18,2	200	18,2	163,6	31,400	10,640

Compound PP-RCT glass fibre reinforced pipes. Diameter range 125×14,0 to 160×14,6 mm. Used in installations: hot utility water (60 °C), with the operating pressure:
 - 8 bar for 125×14,0 mm
 - 6 bar for 160×14,6 mm
 - 8 bar for 200×18,2 mm
 and in heating systems (80 °C, T_{max} = 90 °C), with the operating pressure:
 - 6 bar for 125×14,0 mm
 - 4 bar for 160×14,6 mm
 - 6 bar for 200×18,2 mm
 4 m sections.

Compound pipes Stabi Al

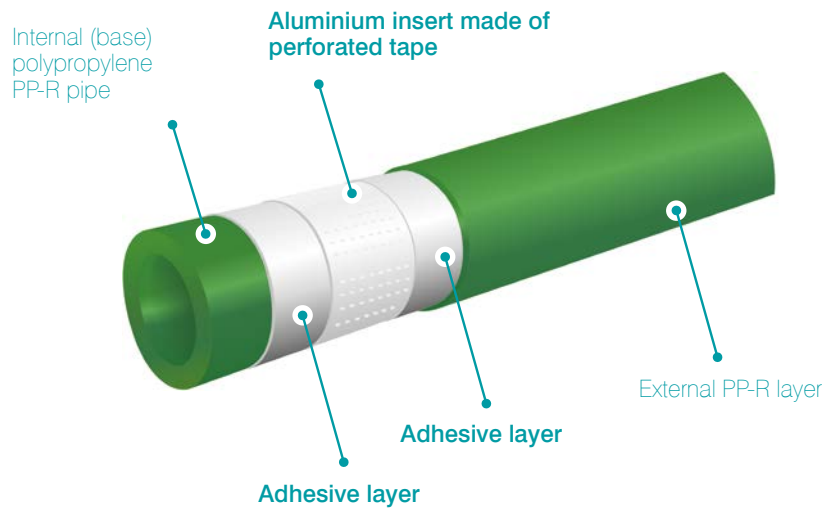

Compound pipes Glass

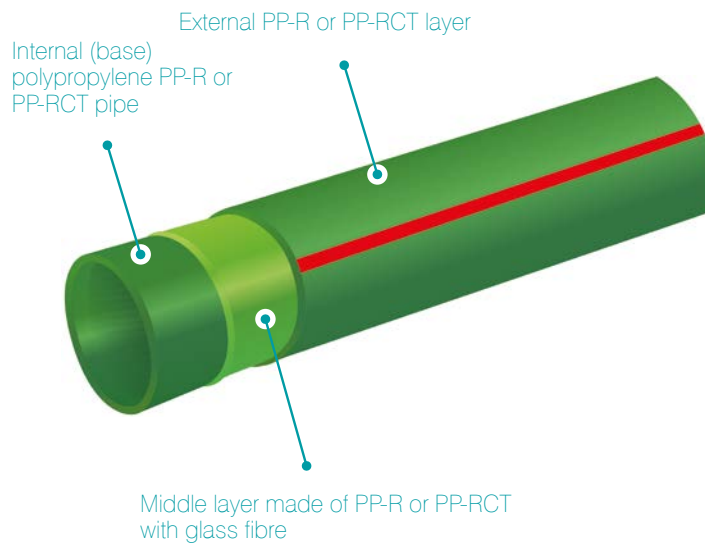

Thermal elongation

Every pipeline, when exposed to temperature difference ΔT , undergoes elongation (or shortening) by the ΔL value. This amount is calculated with the below formula:

$$\Delta L = \alpha \times L \times \Delta T$$

where:

- α – thermal linear elongation coefficient [mm/mK]
 - 0,15 [mm/mK] – homogenous PP pipes
 - 0,05 [mm/mK] – PP Glass and PP-RCT Glass pipes
 - 0,03 [mm/mK] – PP Stabi Al pipes

L – pipeline section length [m]

ΔT – temperature difference during installation and use [K]

Example:

Elongation of 25 m pipe KAN-therm PP Green Stabi Al, KAN-therm PP Green Glass, KAN-therm PP Green homogenous at temperature difference 60°C.

- KAN-therm PP Green Stabi Al $\Delta L = 0,03 \times 25 \times 60 = 45$ [mm]
- KAN-therm PP Green Glass $\Delta L = 0,05 \times 25 \times 60 = 75$ [mm]
- KAN-therm PP Green homogenous $\Delta L = 0,15 \times 25 \times 60 = 225$ [mm]

Elongation of 25 m pipe

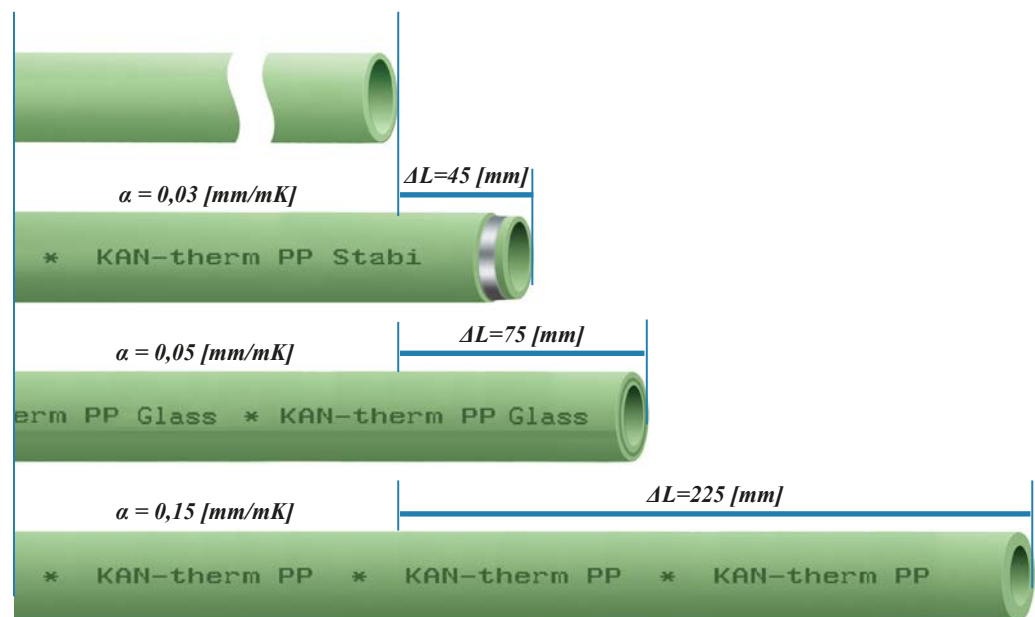

Comparison of thermal elongation KAN-therm PP Green homogeneous, Stabi Al and Glass pipes

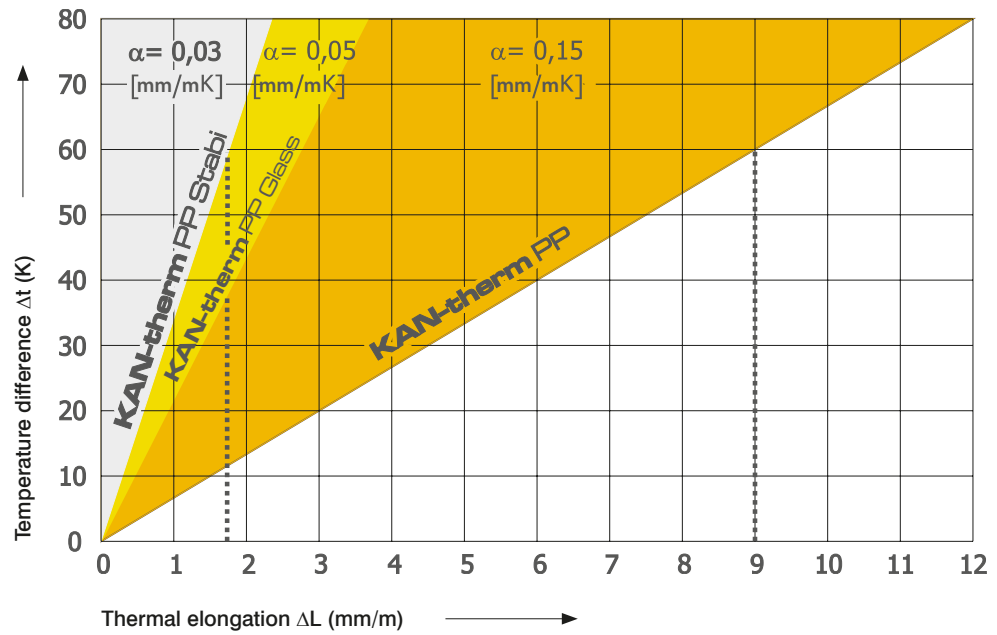

Compensators

In order to eliminate linear elongation effects (uncontrolled movements of pipelines and their deformation), compensation solutions with different structures are used (flexible arm, U- and Z-shape compensators).

$$L_s = K \times \sqrt{D_z \times \Delta L}$$

where:

L_s – flexible arm's length [mm]

K – material coefficient = 20

D_z – external diameter of the pipe [mm]

ΔL – elongation of the pipe-line length [mm]

„L”, „Z”, and „U” compensator selection

Rules for selection of different types of compensators are given below:

„L” type compensator

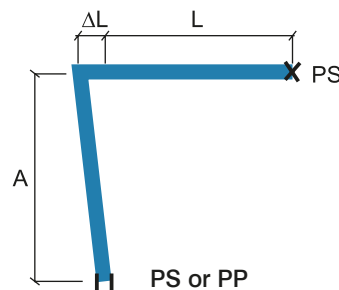

A – flexible arm length

PP – sliding support (allows only axial movement of a pipeline)

PS – fixed point (prevents any movement of a pipeline)

L – the initial length of a pipeline

ΔL – pipeline thermal elongation

For compensation arm A dimensioning, a substitute length $L_z=L$ is taken, and for L_z length the thermal elongation value ΔL , is determined from formula.

„Z” type compensator

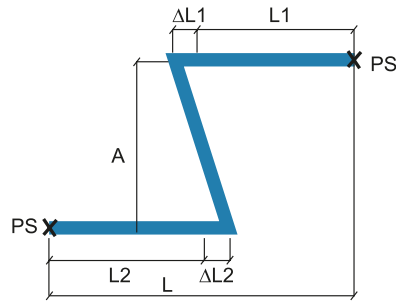

- A – expansion compensation length
- PS – fixed point (prevents the pipeline from moving)
- L – pipeline initial length
- ΔL – pipeline thermal elongation

For compensation arm A dimensioning, $L1$ and $L2$ sum is taken as a substitute length $Lz = L1 + L2$, and for Lz length a substitute ΔL is determined from formula.

„U” type compensator

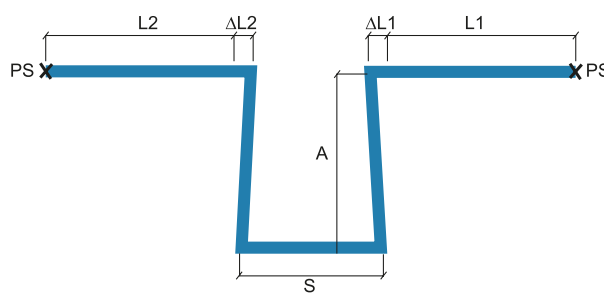

- A – expansion compensation length
- PS – fixed point (prevents the pipeline from moving)
- L – pipeline initial length
- ΔL – pipeline thermal elongation
- S – U type compensator width

In case of placing fixed point PS in the section of compensator length S , for compensation arm A dimensioning, the greater value from $L1$ and $L2$ is taken as a substitute length for Lz : $Lz = \max(L1, L2)$ and for this length the substitute elongation ΔL is determined on the basis of formula. Compensator width $S = A/2$.

Connection technique - socket fusion welding (20-125 mm)

1. Cutting the pipes with scissors.
2. Removing of the aluminum foil with a coarse file (only for compound Stabi Al pipe).



3. Marking of the welding depth.
4. Heating of the pipe and the connector. Parameters:
 - welding depth,
 - welding time.



5. Connecting of the elements.

Parameters:
- joining time.

6. Holding and cooling of the joint.

Parameters:
- cooling time.



CAUTION!

In order to make a tight and strong connection between a pipe and a KAN-therm PP Green System fitting, it is advised to use welding inserts available in the KAN-therm PP Green System offer.

Socket fusion welding parameters				
Ext. pipe diameter	Welding depth	Heating time	Joining time	Cooling time
[mm]	[mm]	[sek.]	[sek.]	[min.]
20	14,0	5	4	2
25	15,0	7	4	2
32	16,0	8	6	4
40	18,0	12	6	4
50	20,0	18	6	4
63	24,0	24	8	6
75	26,0	30	10	8
90	29,0	40	10	8
110	32,5	50	10	8
125	40,0	90	10	8

The heating time of thin-walled pipes (SDR11) is reduced by half (the heating time for fittings remains unchanged). The heating time at external temperatures below +5°C should be increased by 50%.

General requirements for welding

Only the products coming from the same manufacturer can be welded together. Pipes and fittings should be heated simultaneously and not more than once. All operations during a welding process shall be performed without turning a pipe against a fitting and welding ends. It should be taken into account that welding time differs depending on elements' diameters. Welding below 0°C should be avoided. Double, even flow-out on the whole weld surface indicates a good quality of a joint. In case of Stabi Al pipes it is essential to make sure that an aluminum foil has been removed.



**Welding temperature
260°C**

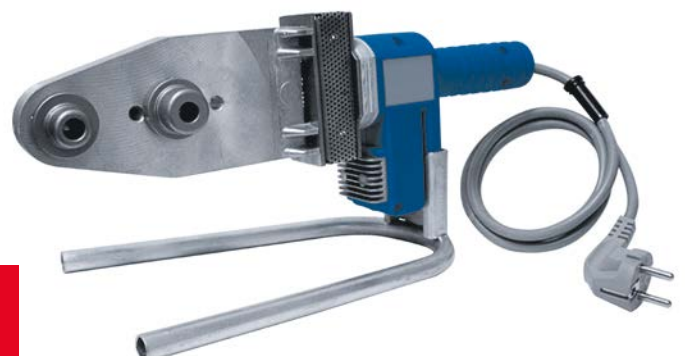

Installation of pipe saddle fittings PP Green

1. Drilling a hole under the pipe saddle fitting
2. Processing the hole – removing the burrs made when drilling.

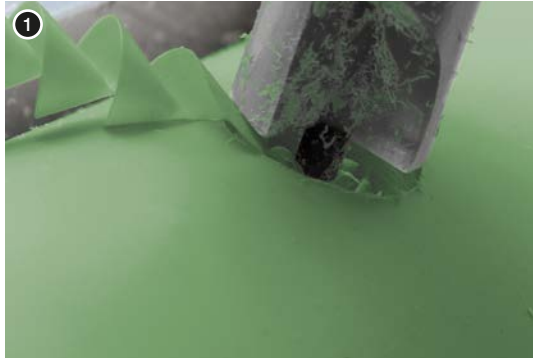

3. Welding the pipe saddle fitting.
4. Ready connection.



Connection technique - electrofusion welding (20-200 mm)

1. Pipe surface scraping.
2. Cleaning pipe surface with alcohol.



3. Insertion depth marking.
4. Insertion of pipe into the fitting.



5. Programming of welding machine via laser reader (welding machine will adjust parameters automatically).
6. Welding process start - do not rotate or mechanically stress the elements through all of welding and cooling process.

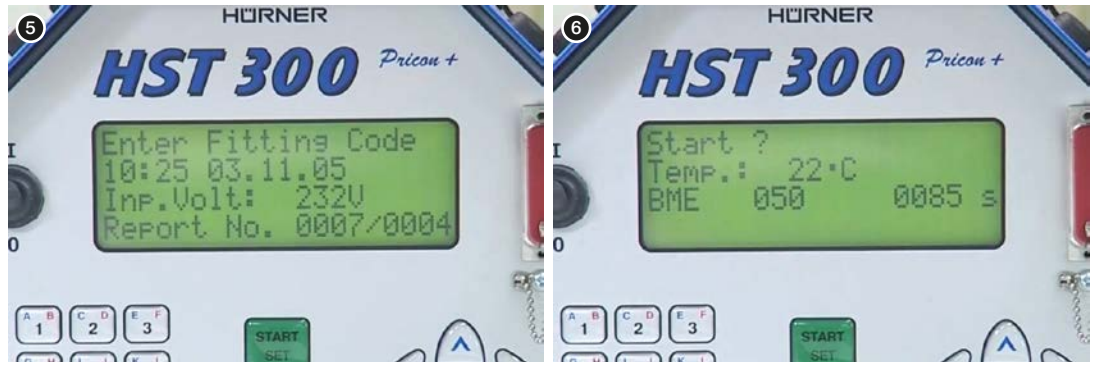

Electrofusion welding parameters				
Ext. pipe diameter	R (23 °C)	RMS	Welding time	Cooling time
[mm]	[Ohm]	[Volt]	[sek.]	[min.]
20	0,76	11	65	10
25	0,76	13	55	10
32	1,25	20	55	10
40	1,90	24	105	10
50	1,41	24	150	15
63	0,85	24	145	15
75	0,79	24	165	20
90	0,76	24	210	20
110	0,57	24	250	20
160	0,84	40	270	30
200	0,56	40	270	30

Thread sealing

It is advised to seal threaded connections with such an amount of hemp, that leaves the thread tops not covered. Using too much hemp may lead to thread damage. By winding hemp just after the first thread ridge you can avoid skew screwing and damaging the thread.

! CAUTION

Do not use chemical sealants or glues.

Tools - safety

All tools must be applied and used in accordance with their purpose and the manufacturer's instructions.

Use for other purposes or in other areas are considered to be inconsistent with the intended use.

Intended use also requires compliance with the instructions, conditions of inspection and maintenance and relevant safety regulations in their current version.

All works done with tools, which do not meet the application compatible with the intended purpose may result in damage to tools, accessories and pipes.

The consequence may be the leak and / or damage.

Installation procedures

Fixed installation points - installation examples (Fig. 1 and 2)

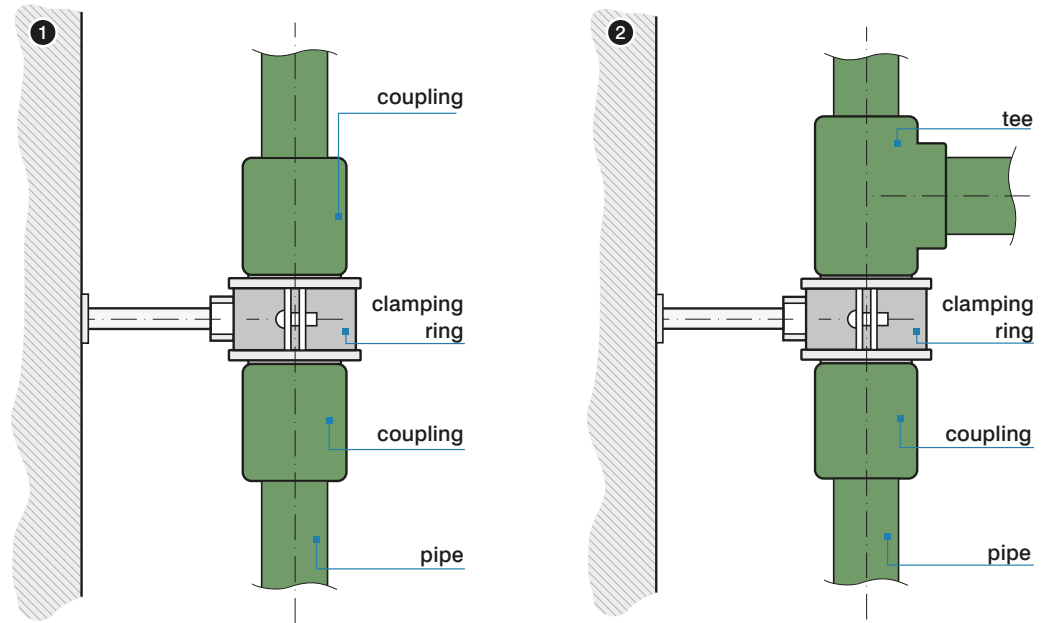

Examples of installation of hot water risers depending on pipe types (Fig. 3 and 4)

3. Installation made of pipes: System KAN-therm PP SDR 7,4; SDR 6.

4. Installation made of pipes: System KAN-therm PP Green Stabi AI and KAN-therm PP Green Glass: PP – slidable point, PS – fixed point

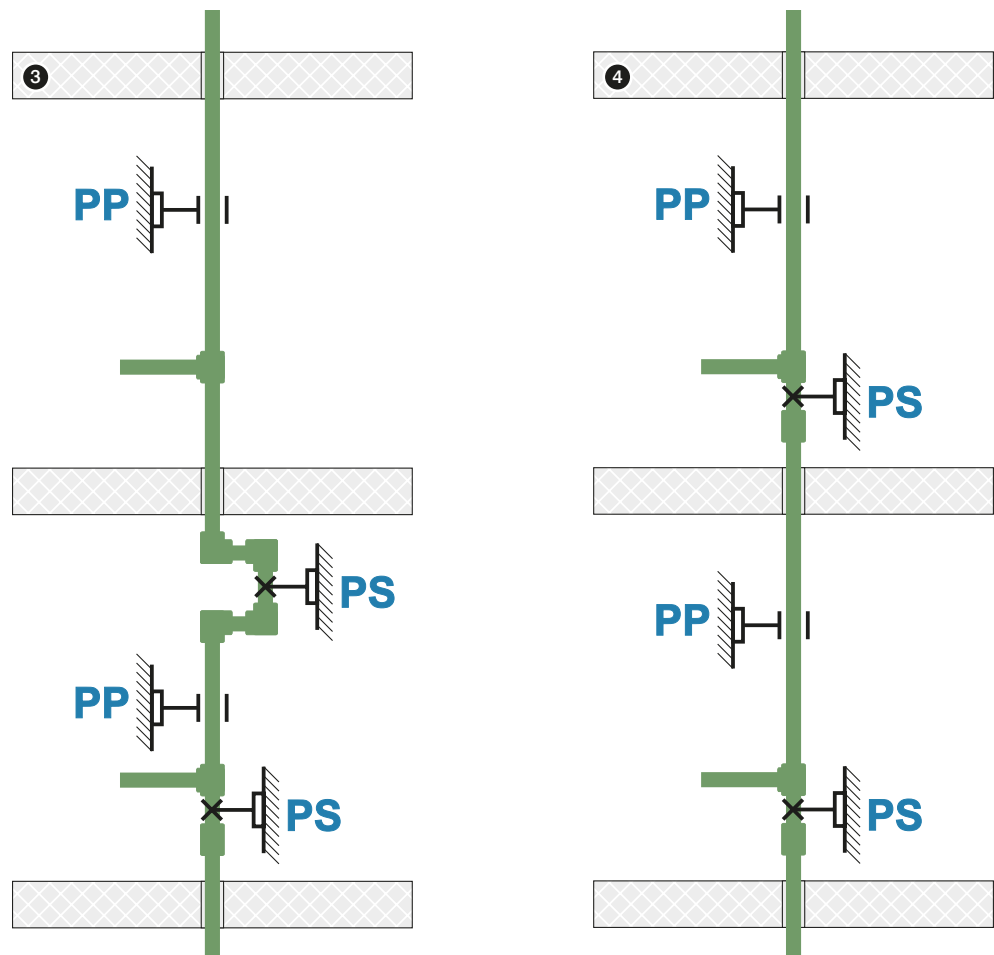

Maximum distances between supports for KAN-therm PP Green System uniform pipes depending on the diameter and medium temperature. For vertical pipeline sections, the distance between the supports can be increased by about 30%.

T [°C]	External pipe diameter D [mm]								
	20	25	32	40	50	63	75	90	110
Distance between fixing points [cm]									
20	60	70	90	100	120	140	150	160	180
30	60	70	90	100	120	140	150	160	180
40	60	65	80	90	110	130	140	150	170
50	60	65	80	90	110	130	140	150	170
60	55	60	75	85	100	115	125	140	160
70	50	60	70	80	95	105	115	125	140

Maximum distances between supports for KAN-therm Stabi Al System pipes depending on the diameter and medium temperature. For vertical pipeline sections, the distance between the supports can be increased by about 30%.

T [°C]	External pipe diameter D [mm]								
	20	25	32	40	50	63	75	90	110
Distance between fixing points [cm]									
20	120	130	150	170	190	210	220	230	250
30	120	130	150	170	190	210	220	230	240
40	110	120	140	160	180	200	210	220	230
50	110	120	140	160	180	200	210	220	210
60	100	110	130	150	170	190	200	210	200
70	90	100	120	140	160	180	190	200	200

Maximum distances between supports for KAN-therm System PP Green Glass/PP-RCT pipes depending on the diameter and medium temperature. For vertical pipeline sections, the distance between the supports can be increased by about 30%.

T [°C]	External pipe diameter D [mm]											
	20	25	32	40	50	63	75	90	110	125	160	200
Distance between fixing points [cm]												
0	120	140	160	180	205	230	245	260	290	225	225	250
20	90	105	120	135	155	175	185	195	215	220	220	245
30	90	105	120	135	155	175	185	195	210	210	210	235
40	85	95	110	125	145	165	175	185	200	205	205	225
50	85	95	110	125	145	165	175	185	190	195	195	220
60	80	90	105	120	135	155	165	175	180	185	185	210
70	70	80	95	110	130	145	155	165	170	175	175	200

Pressure testing

To apply the hydrostatic test pressure with COLD water, conduct the procedure as follows:

- Open the venting system;
- Purge the system with water to expel all air that can be removed. Stop the flow and close the venting system;
- Apply the selected test pressure equal to 1,5 times the design pressure by pumping according to chart during the first 30 min;
- Read the pressure when the first 30 min have elapsed;

- Read the pressure after another 30 min and visually check for leaks. If the pressure has dropped by less than 0,6 bar conclude the system has no obvious leakage and continue the test without further pumping;
- Visually check for leaks and if during the next 2h, the pressure drops by more than 0,2 bar this indicates a leak within the system.

The test result should be recorded.

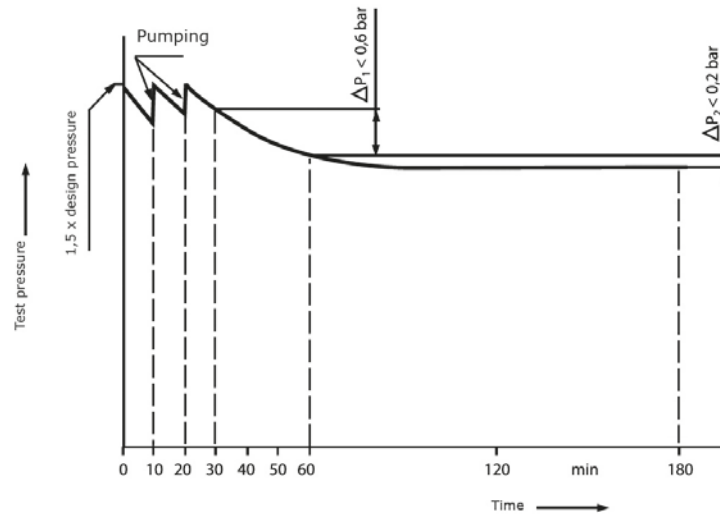

Service life of KAN-therm PP Green system

Service life in hours

Termination of an isotherm indicates maximum service life also at lower tension.

The isotherms in the chart does not extend.

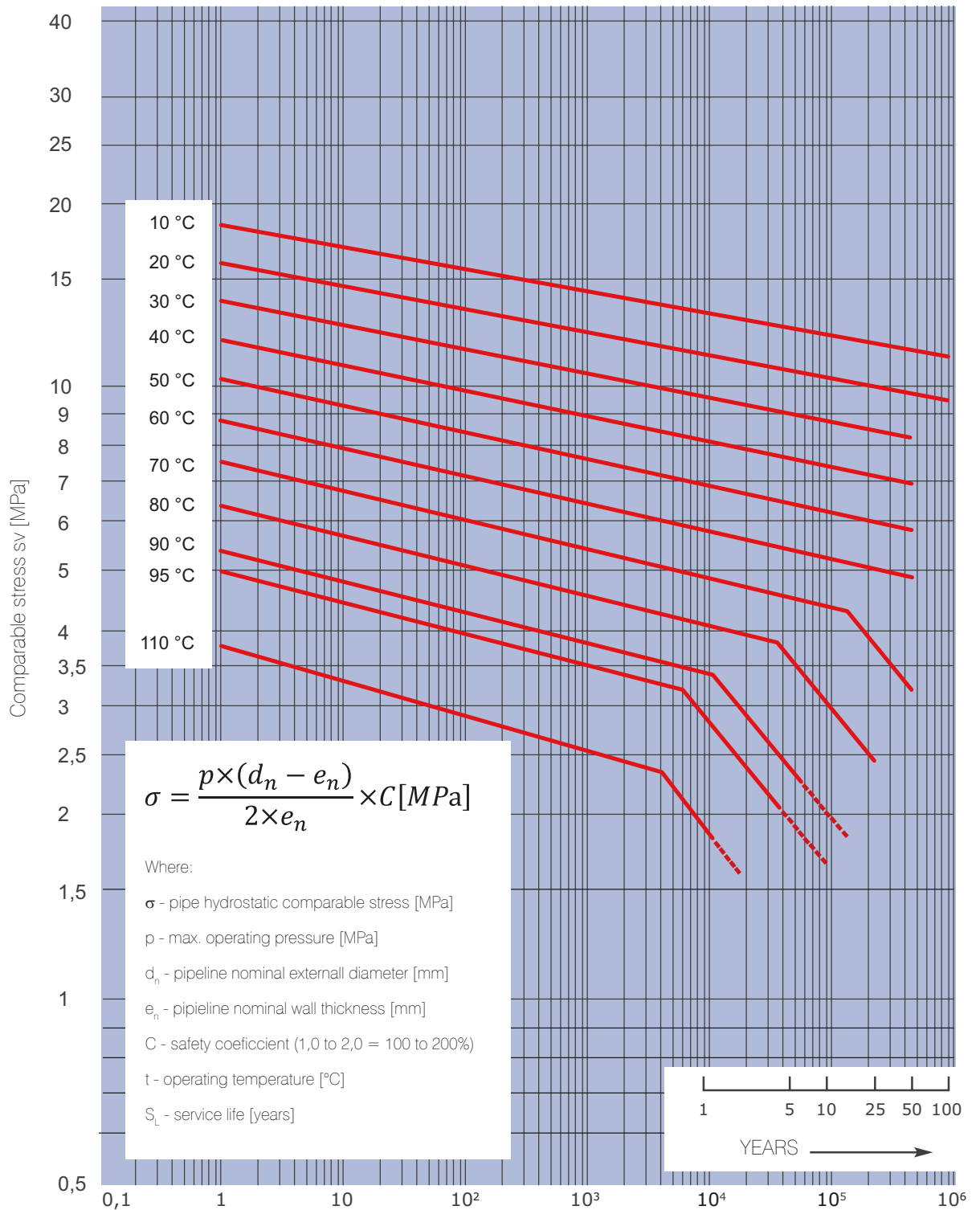

Application areas

Operating conditions according to EN ISO 15874

In terms of pressure and temperature for pipes and fittings, the operating conditions set forth in ISO 15874 are taken as the basic conditions.

Water supply and heating systems are classified according to ISO 15874 in the following way:

Appl. class	Design temp. T_D	Time at T_D	Max. design temp.	Time at T_{max}	Emerg. temp.	Time at $T_{mal.}$	Scope of application
	°C	years	°C	years	°C	hours	
1	60	49	80	1	95	100	Hot water supply (60°C)
2	70	49	80	1	95	100	Hot water supply (60°C)
4	20	2,5	70	2,5	100	100	Floor heating Low temp. radiators
	40	20					
	60	25					
5	20	14	90	1	100	100	High-temperature heating
	60	25					
	80	10					

T_D - design temperature defined by the application

T_{max} - maximum design temperature, with its time-limited exposure

$T_{mal.}$ - malfunction temperature arising under emergencies due to troubles in control systems

Application	Permissible [bar]	Pipe type
Cold tap water $T = 20^\circ\text{C}$	according to pipe application	All pipes
Hot tap water [Application class 1] $T_d/T_{max} = 60/80^\circ\text{C}$	10	SDR6 uniform and Stabi Al pipes; SDR11 Glass PP-RCT pipes
	8	SDR7,4 uniform, Stabi Al and Glass pipes
Hot tap water [Application class 2] $T_d/T_{max} = 70/80^\circ\text{C}$	8	SDR6 uniform and Stabi Al pipes; SDR11 Glass PP-RCT pipes
	6	SDR7,4 uniform, Stabi Al and Glass pipes
Floor heating, low temperature radiator heating [Application class 4] $T_d/T_{max} = 60/70^\circ\text{C}$	10	all pipes except uniform SDR11
Radiator heating [Application class 5] $T_d/T_{max} = 80/90^\circ\text{C}$	6	All pipes except uniform SDR11

Handling and storage

- Components of plastic piping systems must be protected against impact, falling, blow or any other mechanical damage during their transport and installation.



- Only the components that are not damaged or contaminated, during storage or transportation, may be used for installation works.



- A minimum temperature for plastic piping installation, as regards welding, is +5 °C. At lower temperatures it is difficult to provide working conditions for high quality pipe joints.

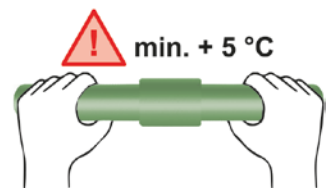

- Pipeline crossings are made by means of the components specially designed for this purpose.



- Joining of plastic parts is done by polyfusion welding which results in a high-quality homogeneous joint. Joining must be performed under specified working conditions with the use of appropriate tools. It is not recommended to weld KAN-therm PP Green components together with other brand products (no warranty).



- Components must not be exposed to open fire.



- Sharp and professional tools can only be used to cut the pipes.



- Protect against sun and rain.



System KAN-therm PP - assortment

uniform pipe SDR11

GROUP: L

Size	*	Code	Packing	UM
20×1,9	**	NG11001	4/200	m
25×2,3	**	NG11002	4/160	m
32×2,9	**	NG11003	4/80	m
40×3,7	**	NG11004	4/60	m
50×4,6	**	NG11005	4/40	m
63×5,8	**	NG11006	4/24	m
75×6,8	**	NG11007	4/20	m
90×8,2	**	NG11008	4/12	m
110×10,0	**	NG11009	4/8	m



uniform pipe SDR7,4

GROUP: L

Size	*	Code	Packing	UM
20×2,8	**	NG11501	4/160	m
25×3,5	**	NG11502	4/100	m
32×4,4	**	NG11503	4/60	m
40×5,5	**	NG11504	4/40	m
50×6,9	**	NG11505	4/28	m
63×8,6	**	NG11506	4/16	m
75×10,3	**	NG11507	4/12	m
90×12,3	**	NG11508	4/8	m
110×15,1	**	NG11509	4/4	m



uniform pipe SDR6

GROUP: L

Size	*	Code	Packing	UM
20×3,4		NG12001	4/160	m
25×4,2		NG12002	4/100	m
32×5,4		NG12003	4/60	m
40×6,7		NG12004	4/40	m
50×8,3		NG12005	4/28	m
63×10,5		NG12006	4/16	m
75×12,5		NG12007	4/12	m
90×15,0	*	NG12008	4/8	m
110×18,3	*	NG12009	4/4	m



Stabi Al pipe SDR7,4

GROUP: M

Size	*	Code	Packing	UM
20×2,8		NG13501	4/100	m
25×3,5		NG13502	4/80	m
32×4,4		NG13503	4/40	m
40×5,5		NG13504	4/28	m
50×6,9		NG13505	4/20	m
63×8,6		NG13506	4/12	m
75×10,3	*	NG13507	4/8	m



* on request (delivery time up to 4 weeks)

** availability by individual arrangements

*** till stock ends

Stabi Al pipe SDR6

GROUP: M

Size	*	Code	Packing	UM
20×3,4	**	NG13002	4/100	m
25×4,2	**	NG13003	4/80	m
32×5,4	**	NG13004	4/40	m
40×6,7	**	NG13005	4/28	m
50×8,3	**	NG13006	4/20	m
63×10,5	**	NG13007	4/12	m
75×12,5	**	NG13008	4/8	m
90×15,0	**	NG13009	4/8	m
110×18,3	**	NG13010	4/4	m



Glass pipe SDR7,4

GROUP: M

Size	*	Code	Packing	UM
20×2,8		NG14001	4/100	m
25×3,5		NG14002	4/80	m
32×4,4		NG14003	4/40	m
40×5,5		NG14004	4/28	m
50×6,9		NG14005	4/20	m
63×8,6		NG14006	4/12	m
75×10,3	*	NG14007	4/8	m
90×12,3	*	NG14008	4/8	m
110×15,1	*	NG14009	4/4	m



Glass pipe PP-RCT SDR9 and SDR11

GROUP: M

Size	*	Code	Packing	UM
125×14,0	**	NG14010	4/4	m
160×14,6	**	NG14011	4/4	m
200×18,2	**	2029206093	4/4	m



saddle coupler PP x Push

GROUP: N

Size	*	Code	Packing	UM
63 / 18×2	*	2009238035	20/160	pc
75 / 18×2	*	2009238036	20/160	pc
90 / 18×2	*	2009238037	20/160	pc
110 / 18×2	*	2009238038	20/160	pc



saddle coupler PP female thread

GROUP: N

Size	*	Code	Packing	UM
63×GW½ / 18×2	*	NG65003	20/160	pc
75×GW½ / 18×2	*	NG65004	20/160	pc
90×GW½ / 18×2	*	NG65005	20/160	pc
110×GW½ / 18×2	*	NG65006	20/160	pc

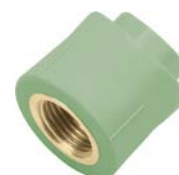

* on request (delivery time up to 4 weeks)

** availability by individual arrangements

*** till stock ends

loop compensation

GROUP: N

Size	*	Code	Packing	UM
20		NG80011	20	m
25		NG80012	15	m
32		NG80013	10	m

Crossover's diameter Ø150, length 370 mm



crossover

GROUP: N

Size	*	Code	Packing	UM
20		NG80001	150	m
25		NG80002	100	m
32		NG80003	60	m



straight coupling

GROUP: N

Size	*	Code	Packing	UM
20		NG30001	100/700	pc
25		NG30002	50/550	pc
32		NG30003	40/280	pc
40		NG30004	30/180	pc
50		NG30005	-/110	pc
63		NG30006	-/60	pc
75	*	NG30007	-/45	pc
90	*	NG30008	-/24	pc
110	*	NG30009	-/16	pc
125	**	NG30010	-/9	pc



* on request (delivery time up to 4 weeks)

** availability by individual arrangements

*** till stock ends

reducer

GROUP: N

Size	*	Code	Packing	UM
25×20		NG40002	100/900	pc
32×20		NG40003	80/640	pc
32×25		NG40004	80/560	pc
40×20		NG40005	50/400	pc
40×25		NG40006	50/350	pc
40×32		NG40007	50/300	pc
50×25		NG40019	30/120	pc
50×32		NG40008	30/180	pc
50×40		NG40009	30/150	pc
63×32		NG41000	-/100	pc
63×40		NG40010	-/100	pc
63×50		NG40011	-/100	pc
75×50	*	NG40012	-/80	pc
75×63	*	NG40013	-/50	pc
90×50	*	NG40014	-/48	pc
90×63	*	NG40015	-/45	pc
90×75	*	NG40016	-/45	pc
110×63	*	NG40018	-/27	pc
110×75	*	NG40024	-/27	pc
110×90	*	NG40017	-/27	pc
125×110	**	NG40021	-/6	pc
160×110	**	NG40022	-/2	pc
160×125	**	NG40023	-/4	pc
200×160	**	2009220114	-/1	pc



straight female connector

GROUP: N

Size	*	Code	Packing	UM
20×½"		NG60002	20/180	pc
20×¾"		NG60003	30/150	pc
25×½"		NG60004	20/160	pc
25×¾"		NG60005	30/150	pc
25×1"		2009245207	100	pc
32×¾"		NG60015	20/60	pc
32×1"		NG60006	-/100	pc
40×1¼"		NG60007	-/60	pc
50×1½"		NG60008	-/35	pc
63×2"		NG60009	-/18	pc
75×2½"	*	NG60010	-/12	pc
90×3"	*	NG60011	-/8	pc

Caution:
spanner can be used within the element.



straight male connector

GROUP: N

Size	*	Code	Packing	UM
20×½"		NG61002	20/160	pc
20×¾"		NG61003	30/120	pc
25×½"		NG61004	20/140	pc
25×¾"		NG61005	30/120	pc
25×1"		2009245201	80	pc
32×1"		NG61006	-/80	pc
32×1¼"		2009245202	50	pc
40×1¼"		NG61007	-/50	pc
50×1½"		NG61008	-/36	pc
63×2"		NG61009	-/18	pc
75×2½"	*	NG61010	-/10	pc
90×3"	*	NG61011	-/6	pc

Caution:
spanner can be used within the element



elbow 90°

GROUP: N

Size	*	Code	Packing	UM
20		NG29001	100/500	pc
25		NG29002	50/350	pc
32		NG29003	20/200	pc
40		NG29004	20/120	pc
50		NG29005	60	pc
63		NG29006	32	pc
75	*	NG29007	20	pc
90	*	NG29008	12	pc
110	*	NG29009	8	pc
125	**	NG29010	-/1	pc
160	**	NG29011	-/2	pc
200	**	2009068215	-/1	pc



nipple elbow 90°

GROUP: N

Size	*	Code	Packing	UM
20		NG29101	100/600	pc
25		NG29102	50/400	pc
32		NG29103	50/200	pc



* on request (delivery time up to 4 weeks)

** availability by individual arrangements

*** till stock ends

elbow 45°

GROUP: N

Size	*	Code	Packing	UM
20		NG24501	100/700	pc
25		NG24502	50/400	pc
32		NG24503	40/200	pc
40		NG24504	20/140	pc
50		NG24505	-/80	pc
63		NG24506	-/40	pc
75	*	NG24507	-/25	pc
90	*	NG24508	-/14	pc
110	*	NG24509	-/4	pc
125	**	NG24510	-/4	pc
160	**	NG24511	-/2	pc
200	**	2009068214	-/1	pc



nipple elbow 45°

GROUP: N

Size	*	Code	Packing	UM
20		NG29201	100/700	pc
25		NG29202	50/450	pc



wallplate elbow

GROUP: N

Size	*	Code	Packing	UM
20 × 1/2"		NG23001	20/140	pc
25 × 1/2"		NG23002	20/120	pc



male elbow 90°

GROUP: N

Size	*	Code	Packing	UM
20 × 1/2"		NG22001	30/90	pc
20 × 3/4"		NG22002	30/90	pc
25 × 1/2"		NG22003	20/120	pc
25 × 3/4"		NG22004	30/90	pc
32 × 3/4"		NG22005	30/60	pc
32 × 1"		NG22006	-/50	pc



elbow with female thread

GROUP: N

Size	*	Code	Packing	UM
20 × 1/2"		NG21001	20/140	pc
20 × 3/4"		NG21002	30/120	pc
25 × 1/2"		NG21003	20/120	pc
25 × 3/4"		NG21004	30/120	pc
32 × 3/4"		NG21005	30/90	pc
32 × 1"		NG21006	-/50	pc



* on request (delivery time up to 4 weeks)

** availability by individual arrangements

*** till stock ends

reducing tee

GROUP: N

Size	*	Code	Packing	UM
25×20×20		NG51014	20/200	pc
25×25×20		NG51015	20/200	pc
25×20×25		NG51001	20/240	pc
32×20×20		NG51016	20/200	pc
32×20×32		NG51002	20/140	pc
32×25×25		NG51018	20/140	pc
32×25×32		NG51003	20/140	pc
40×20×40		NG51004	20/80	pc
40×25×40		NG51005	15/90	pc
40×32×40		NG55001	15/90	pc
50×20×50		NG51006	-/60	pc
50×25×50		NG51007	-/65	pc
50×32×50		NG51008	-/60	pc
50×40×50		NG55002	-/50	pc
63×25×63		NG51019	-/24	pc
63×32×63		NG55003	-/30	pc
63×40×63		NG51009	-/22	pc
75×40×75	*	NG51010	-/17	pc
90×50×90	*	NG51013	-/12	pc
90×63×90	*	NG51012	-/10	pc
90×75×90	*	NG51011	-/12	pc
110×63×110	*	NG51020	-/4	pc
125×110×125	**	NG51021	-/1	pc
160×110×160	**	NG51022	-/1	pc
160×90×160	**	NG51024	-/1	pc
200×90×200	**	2009257097	-/1	pc
200×110×200	**	2009257098	-/1	pc
200×125×200	**	2009257099	-/1	pc
200×160×200	**	2009257100	-/1	pc



tee

GROUP: N

Size	*	Code	Packing	UM
20		NG50001	80/400	pc
25		NG50002	20/240	pc
32		NG50003	20/140	pc
40		NG50004	15/75	pc
50		NG50005	-/50	pc
63		NG50006	-/24	pc
75	*	NG50007	-/15	pc
90	*	NG50008	-/10	pc
110	*	NG50009	-/8	pc
125	**	NG50010	-/1	pc
160	**	NG50011	-/1	pc
200	**	2009257096	-/1	pc



* on request (delivery time up to 4 weeks)

** availability by individual arrangements

*** till stock ends

corner tee

GROUP: N

Size	*	Code	Packing	UM
20		NG50050	40/360	pc



four way fitting

GROUP: N

Size	*	Code	Packing	UM
20	*	NG54001	40/320	pc



tee with male thread

GROUP: N

Size	*	Code	Packing	UM
20×½"		NG53001	20/120	pc



tee with female thread

GROUP: N

Size	*	Code	Packing	UM
20×½"×20		NG52001	20/120	pc
20×¾"×20		NG52002	30/90	pc
25×½"×25		NG52003	20/180	pc
25×¾"×25		NG52004	30/180	pc
32×¾"×32		NG52005	15/60	pc
32×1"×32		NG52006	15/60	pc



straight union with gasket

GROUP: N

Size	*	Code	Packing	UM
20×¾"	*	NG62001	20/200	pc



half union

GROUP: N

Size	*	Code	Packing	UM
20×¾"		NG63501	50/400	pc
25×1"		NG63502	20/100	pc



* on request (delivery time up to 4 weeks)

** availability by individual arrangements

*** till stock ends

straight union

GROUP: N

Size	*	Code	Packing	UM
20×½"		NG63001	20/200	pc
20×¾"		NG63002	20/200	pc
25×¾"		NG63003	20/100	pc
25×1"		NG63004	20/100	pc
32×1"		NG63100	20/60	pc



flange

GROUP: N

Size	*	Code	Packing	UM
110 with groove	**	NG80501	-/16	pc
110 without groove	**	NG80502	-/16	pc
125	**	NG80503	-/2	pc
160	**	NG80504	-/2	pc
200	**	2009245209	-/1	pc



steel flange PN16

GROUP: N

Size	*	Code	Packing	UM
110	**	04109014	1/20	pc
125	**	NG80603	1	pc
160	**	NG80604	1	pc
200	**	2009025056	1	pc



bend 90°

GROUP: N

Size	*	Code	Packing	UM
20	**	NG29501	30/300	pc
25	**	NG29502	20/180	pc
32	**	NG29503	15/180	pc



electro-fusion sockets PP-RCT

GROUP: N

Size	*	Code	Packing	UM
20	**	NG97001	20/120	pc
25	**	NG97002	20/120	pc
32	**	NG97003	20/120	pc
40	**	NG97004	10/30	pc
50	**	NG97005	5/20	pc
63	**	NG97006	5/15	pc
75	**	NG97007	4/8	pc
90	**	NG97008	2/8	pc
110	**	NG97009	1/4	pc
125	**	NG97010	1/1	pc
160	**	NG97011	1/1	pc
200	**	2009088036	-/1	pc



* on request (delivery time up to 4 weeks)

** availability by individual arrangements

*** till stock ends

stop end

GROUP: N

Size	*	Code	Packing	UM
20		NG70001	200/1000	pc
25		NG70002	100/700	pc
32		NG70003	50/500	pc
40		NG70004	50/250	pc
50		NG70005	-/170	pc
63		NG70006	-/80	pc
75	*	NG70007	-/50	pc
90	*	NG70008	-/30	pc
110	*	NG70009	-/20	pc
125	**	NG70010	-/10	pc
160	**	NG70011	-/8	pc
200	**	2009025055	-/1	pc



ball valve

GROUP: N

Size	*	Code	Packing	UM
20		NG90001	10/90	pc
25		NG90002	10/50	pc
32		NG90003	5/25	pc
40		NG90004	5/15	pc
50		NG90005	2/10	pc
63		NG90006	2/8	pc
75	*	NG90007	1/5	pc



globe valve

GROUP: N

Size	*	Code	Packing	UM
20		NG92001	1/30	pc
25		NG92002	1/30	pc
32		NG92003	1/30	pc



concealed globe valve

GROUP: N

Size	*	Code	Packing	UM
20		NG93001	1/30	pc
25		NG93002	1/30	pc
32		NG93003	1/30	pc

Valves delivered with two plugs for marking hot water (red) or cold water (blue).



concealed globe valve with masking and mini handle

GROUP: N

Size	*	Code	Packing	UM
20		NG93201	1/30	pc
25		NG93202	1/30	pc
32	**	NG93203	1/30	pc



* on request (delivery time up to 4 weeks)

** availability by individual arrangements

*** till stock ends

pipe clamp

GROUP: N

Size	*	Code	Packing	UM
20		NG81001N	20/800	pc
25		NG81002N	20/700	pc
32		NG81003N	20/440	pc
40		NG81004N	20/300	pc
50		NG81005N	20/240	pc
63		NG81006N	20/120	pc
75	*	NG81007N	20/100	pc
90	*	NG81008N	10/60	pc

Caution:

Use only for uniform pipes. For compound pipes use clamps with rubber insert.



single pipe clamp with rubber insert - double-sided lock with metric thread

GROUP: A

Size	*	Code	Packing	UM
20-23		UP-G20	100	pc
25-28		UP-G25	100	pc
32-36		UP-G32	50	pc
40-44		UP-G40	50	pc
47-52		UP-G50	50	pc
57-63		UP-G63	50	pc
75		UP-G75	25	pc
90		UP-G90	25	pc
110		UP-G110	25	pc
125	**	2009107075	20	pc
160	**	2009107076	10	pc
200	**	2009107077	10	pc

Caution:

Single pipe clamp with rubber insert contains the closing screws (code WK 8x70) and extension anchor (code KR-12).



double pipe clamp with rubber insert - double-sided lock with metric thread

GROUP: A

Size	*	Code	Packing	UM
20		UD-G20	50	pc
25		UD-G25	50	pc
32		UD-G32	50	pc

Caution:

Single pipe clamp with rubber insert contains the closing screws (code WK 8x70) and extension anchor (code KR-12).



plastic mounting plate

GROUP: N

Size	*	Code	Packing	UM
150 mm distance		NG81101	30/150	pc



* on request (delivery time up to 4 weeks)

** availability by individual arrangements

*** till stock ends

Tools

coarse file for Stabi Al pipe

GROUP: K

Size	*	Code	Packing	UM
20/25		04212020	1	pc
25/32		04212025	1	pc
32/40		04212032	1	pc
50		04212050	1	pc
63		04212063	1	pc
75		04212075	1	pc
90		04212090	1	pc
110		04212011	1	pc



coarse file blade

GROUP: K

	*	Code	Packing	UM
	*	04210000	1	pc



pipe cutters

GROUP: K

Size	*	Code	Packing	UM
20-40 mm		04212200	1	pc



roll-cutters

GROUP: K

Size	*	Code	Packing	UM
50-110 mm		04212201	1	pc

Roll-cutter is not suitable for 110 mm SDR6 Stabi Al pipes.



electric cutter

GROUP: K

Size	*	Code	Packing	UM
50-200 mm		845004	1	pc

The set contains the pipe cutting machine and cutting wheel.



support for the pipe for pipe cutting machine

GROUP: K

	*	Code	Packing	UM
		845220	1	pc



wheel for electric roll-cutters

GROUP: K

Size	*	Code	Packing	UM
125-200	*	1933267072	1	pc



* on request (delivery time up to 4 weeks)

** availability by individual arrangements

*** till stock ends

stationary PP-R welding machine

GROUP: K

Size, power	*	Code	Packing	UM
63-110mm, 1600W		04212103	1	pc

Set includes:

- Welding machine set PZ-125
- welding machine 1600W
- Tool case (for welding machine, pipe clamps and welding sockets)
- pipe clamps Ø 63
- pipe clamps Ø 75
- pipe clamps Ø 90
- pipe clamps Ø 110

Caution:

Set does not include welding sockets!



electrofusion welding machine

GROUP: K

Size, power	*	Code	Packing	UM
20-200, 3000 W		1933267071	1	pc



butt-welding machine

GROUP: K

Size, power	*	Code	Packing	UM
125-200, 3500 W		1933267070	1	pc



welding machine

GROUP: K

Size, power	*	Code	Packing	UM
20-50 mm, 800 W		04212100	1	pc
63-125 mm*, 1600 W		04212101	1	pc

Caution:

Every set includes: electric welding machine, welding machine's stand, metal box, set of inserts (*up to 110 mm in set).



long clamping screw for welding machine PP - maintenance component

GROUP: K

	*	Code	Packing	UM
		04212104	1	pc



* on request (delivery time up to 4 weeks)

** availability by individual arrangements

*** till stock ends

tool kit for saddle coupler assembly

GROUP: K

Size, name	*	Code	Packing	UM
63 - set of welding inserts		04212463	1	pc
75 - set of welding inserts		04212475	1	pc
90 - set of welding inserts		04212490	1	pc
110 - set of welding inserts		04212411	1	pc
25 - drill		04212425	1	pc



welder inserts

GROUP: K

Size	*	Code	Packing	UM
20		04212320	1	pc
25		04212325	1	pc
32		04212332	1	pc
40		04212340	1	pc
50		04212350	1	pc
63		04212363	1	pc
75		04212375	1	pc
90		04212390	1	pc
110		04212311	1	pc
125	**	04212312	1	pc



* on request (delivery time up to 4 weeks)

** availability by individual arrangements









*** till stock ends



SYSTEM **KAN-therm**

Optimal, complete multipurpose installation system consisting of state of the art, mutually complementary technical solutions for pipe water distribution installations, heating installations, as well as technological and fire extinguishing installations.

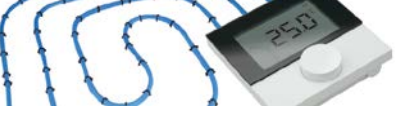
It is the materialization of a vision of a universal system, the fruit of extensive experience, the passion of KAN's constructors, strict quality control of our materials and final products, and vast knowledge of the market of installations to meet the requirements of energy efficient, sustainable construction.

	Push Platinum	
	Push	
	Press LBP	
	PP	
	Steel	
	Inox	
	Sprinkler	
	Underfloor heating and automation	
	Football Stadium installations	
	Cabinets and manifolds	



KAN-therm GmbH
Brüsseler Straße 2, D-53842 Troisdorf-Spich

KAN-therm International Sales Office
Zdrojowa Str., 51, 16-001 Białystok-Kleosin
tel. +48 85 74 99 200,
fax +48 85 74 99 201
e-mail: kan@kan-therm.com