



C.R.I. PUMPS

Pumping trust. Worldwide.

Circulatory Pumps

50 Hz



* For Specific Models Only.



C.R.I. PUMPS

Pumping trust. Worldwide.

T H E B E G I N N I N G

of C.R.I., way back in 1961, was a resolute attempt to produce a few irrigation equipments using the limited facilities of an in-house foundry. Eventually the founder's dream was coming true as the small production unit he started kept growing rapidly. Now, after more than five eventful decades, it is an enormous, widely reputed organization, which produces more than 1000 varieties of perfectly engineered pumps and motors and sells its products in numerous countries spread across 6 continents.

C . R . I . I S O N E A M O N G

the few pioneers in the world to produce 100% stainless steel submersible pumps. Having achieved a record production capacity of over one million pumps per annum, today C.R.I. is rubbing its shoulders with the best brands in the world, with advanced technology and safety standards as its hallmarks.

T H E I N F R A S T R U C T U R E

of C.R.I. is pretty comprehensive with state-of-the-art machineries and a high potential in-house R&D recognised by the ministry of science and technology, Govt. of India - all within its own covered area of 150,000 square metres. The production environment is accredited with ISO 9001 & 14001 certifications and the product are CE, UR/UL, TSE & ISI Certified. The R&D team always stays in tune with the changing scenario and seldom fails in coming up with outstanding solutions every time.

N E E D L E S S T O S A Y ,

behind this legendary growth lies the untiring, innovative, enthusiastic and dedicated team work. And, of course, a flawlessly maintained value system too. The name C.R.I. itself encapsulates the company's ethos: "Commitment, Reliability, Innovation".

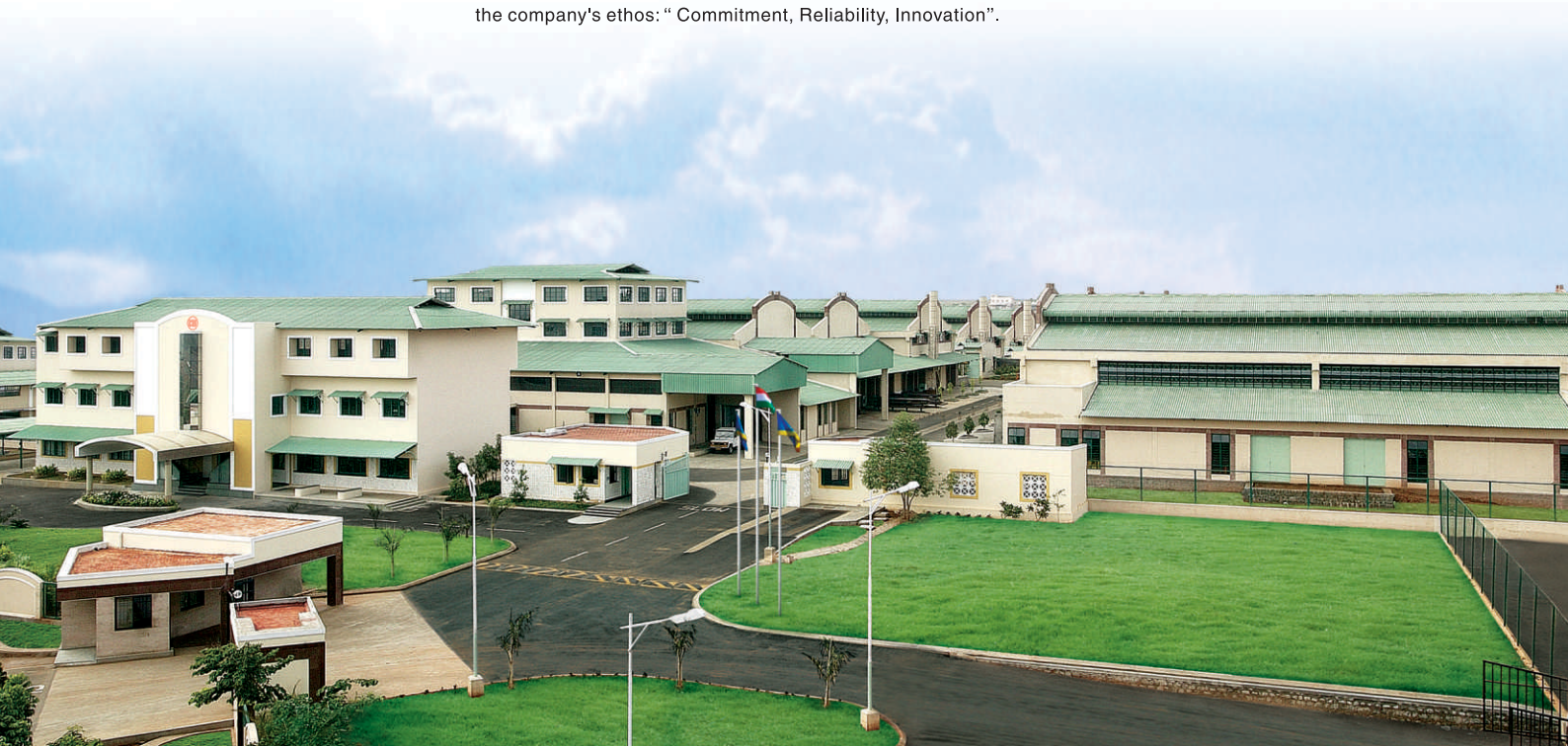

Description

Technological competence and immense experience of C.R.I. pumps always inspire its Engineers in an optimistic manner to come out with successful and innovative products. These single head circulatory pumps are yet another quality products from the house of C.R.I. which can meet the demanding technological challenges, and stand as testimony to C.R.I.'s quality & consistent performance for years.

C.R.I. Circulatory pumps are used to circulate hot / cold water with adequate pressure in HVAC systems. All parts & components have been uncompromisingly tested to ensure trouble free performance and safety operation. The motor is of 2 pole asynchronous and squirrel cage type and consists of canned rotor portion. All the rotating parts are in touch with pumped liquid and thus it acts as lubricant to rotor, shaft & thrust bearings. An air vent plug is provided in the rear-end.

The centrifugal impeller is of radial & closed type with corrosion resistant curved blades. Impeller, shaft with rotor, thrust bearing pad and the intermediate rings are assembled as a single unit to avoid the misalignment of the bearings. The thrust bearing is designed to withstand high axial thrust load.

The particular model of pumps are equipped with a rotary switch in the terminal box that can be used to control the speed in 3 different levels based on the requirement. For trouble free operation the temperature of the pumped liquid should not exceed the specified level, the minimum inlet pressure should be maintained (to avoid cavitations) and dry run must totally be avoided. As the motor is impedance protected and consequently short-circuit proof, no additional motor protection is required. The pump is provided with standard length of cable lead out with plug.

These circulatory pumps are generally used in tandem with heating systems.

Applications

- Domestic heating systems.
- Air conditioning.
- Cooling system.
- Industrial hot water circulatory systems.

Pumped Liquid

- Clean, thin, non aggressive, non-explosive, clear cold or hot water without abrasives, solid particles & fibers.
- Water with specified chemical additives.
- Water mixed with glycol in 1:1 ratio.
- The pump is not strictly recommended for inflammable liquids such as Diesel, Petrol, Oil, Chemicals etc.,



Special Features

- Tried and trusted.
- Highly efficient.
- Corrosion free parts for hygiene.
- Low wear and tear.
- Easy for installation & service.
- Multi speed control (3 Levels).
- Perfectly and aesthetically designed.
- Silent operation & reduced electrical energy consumption.

Technical data

Ambient Temperature	: 40°C
Maximum humidity	: 95%
Liquid temp. range	: -5°C to +110°C
Max. Operating Pressure	: 10bar
Voltage	: Single phase 230V
Frequency	: 50 Hz
Degree of Protection	: IP 44
Insulation Class	: F
Mounting position	: Horizontal
Connection type	: Screw / Flange
Head	: Single

Minimum Inlet Pressure

To avoid cavitation noise and to ensure long life operation, a pressure of minimum 2.0m head / 0.2 bar is required at the pump suction port during operation.

Location of Pump

The pump must be installed in a non aggressive & non explosive environment.

Warning

To prevent fatal or serious electric shock, disconnect main power supply before working on or around the water system. Only technically qualified personnel must perform the work complying with local electrical rules and regulations. To reduce the risk of electrical shock during operation of the pumpset, an appropriate earthing is mandatory. Do not run the pump in closed valve condition.

Speed Settings

The rotary switch provided in the terminal box can be turned to three different positions to adjust / control the speed based on the requirement, as mentioned in the table. Changing the speed to the lower level not only helps to save energy but also to reduce the noise considerably. The pressure level also can be increased or decreased by changing the pump speed, subject to the available inlet pressure.

Switch Positions	Approx max Speed in %
I	60%
II	80%
III	100%

Model Identification Code

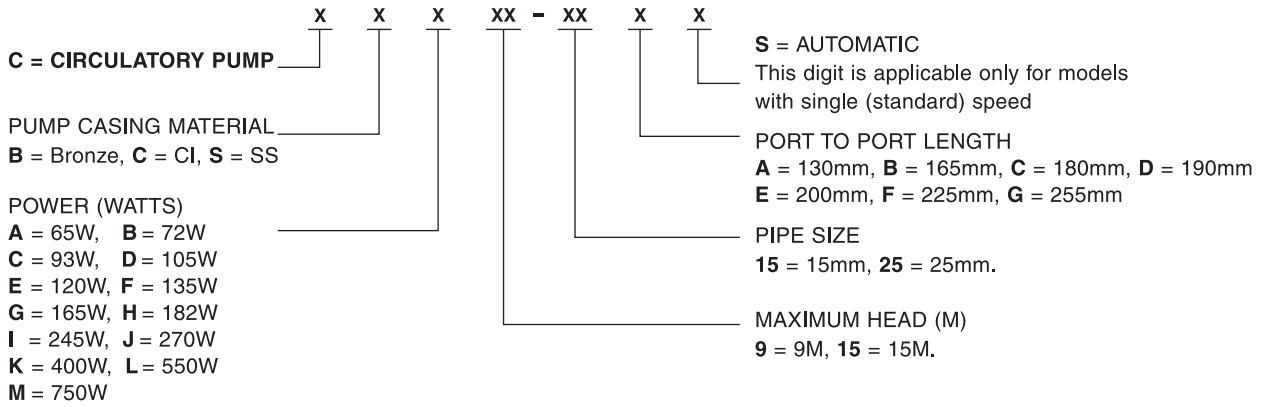

Exploded View

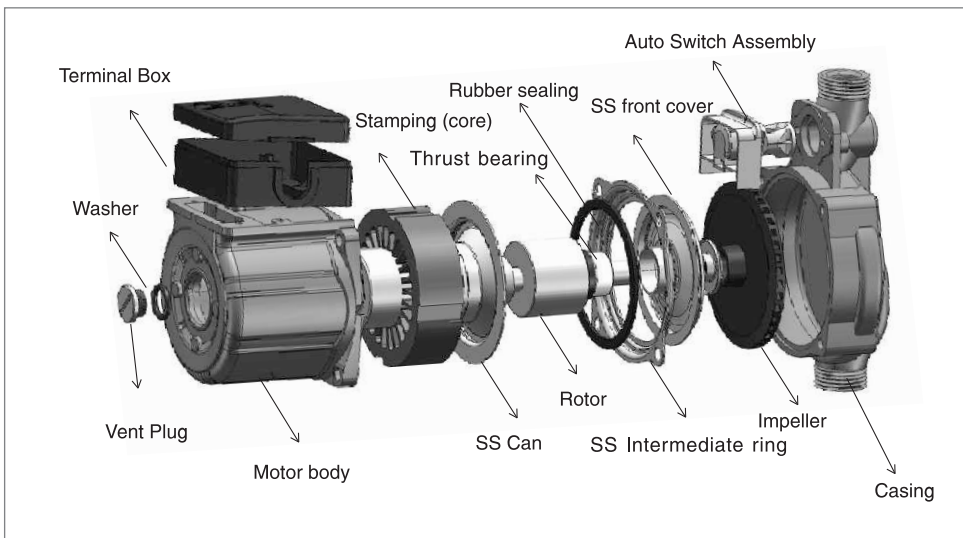

Materials of Construction

Description	Materials
Casing	Cast Iron
Impeller	Composite PP
Shaft	Ceramic
Motor Body	Al. Die Casting
Thrust Bearing	Graphite Carbon & Ceramic
Terminal Box / Cover	Composite PPE / PS
'O' ring	EPDM Rubber
Vent Plug	Brass
Bearing Plate	Stainless Steel
Intermediate ring	Stainless Steel

Name Plate Data

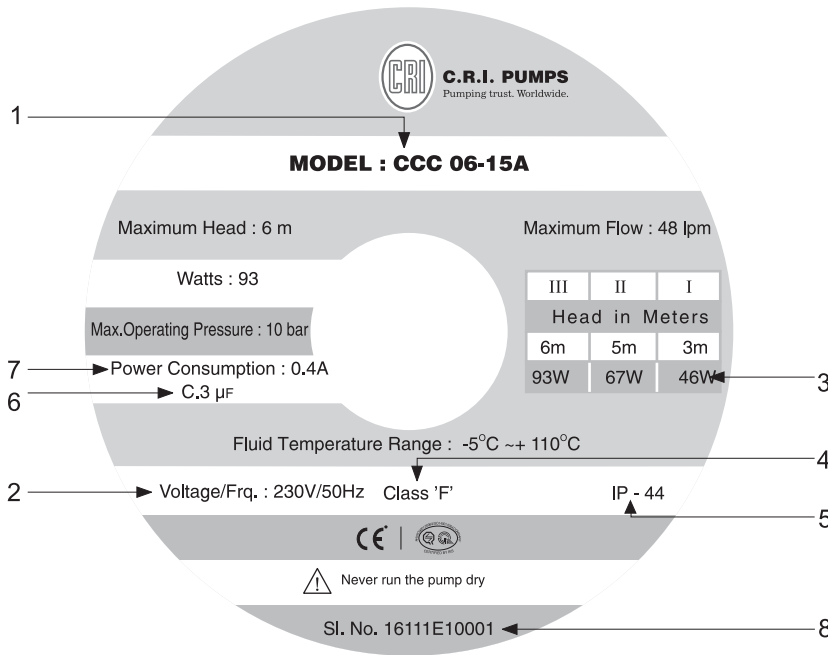

S.No	Description
1	Pump Model
2	Voltage (V) & Frequency (Hz)
3	Power in (W)
4	Insulation class
5	Ingress Protection
6	Capacitor value (µF)
7	Full - Load current (A)
8	Pump Serial No.

Electrical Connections

Single Phase

Terminal L - Phase

N - Neutral

- Earth

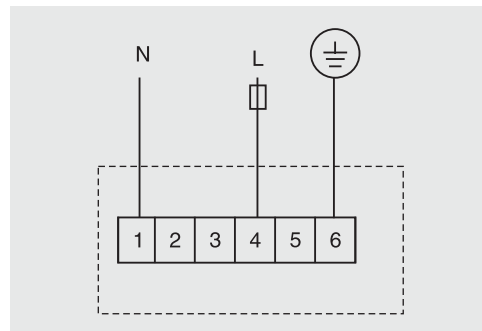

Pump Maintenance

The minimum inlet pressure must be maintained to avoid cavitation noise and vibration.

Ensure the pipe system is properly filled and vented ; normally the pump is vented automatically after a short period of operation. If cavity noise occurs or vibration occurs direct venting of pump is required.

Minimum inlet pressure at suction port		
At +85°C	0.5 bar	(up to 300m msl)
At +95°C	0.3 bar	(up to 300m msl)
At +110°C	1 bar	(up to 300m msl)

Utmost care must be taken during direct venting of the pump, take care during the release of hazardous hot water or vapor depending upon the fluid temperature. Generally the C.R.I. Circulatory pumps are maintenance free.

In view of the continuous developments the Information / Descriptions / Specifications / illustrations are subject to change without prior notice.

Auto Switch Maintenance

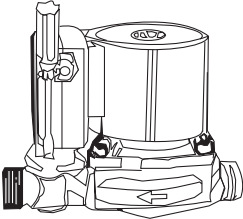
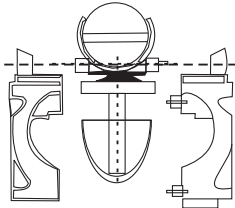
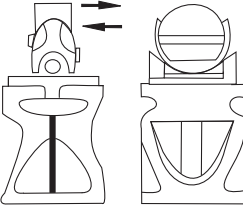
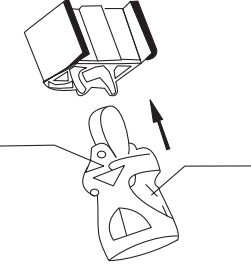
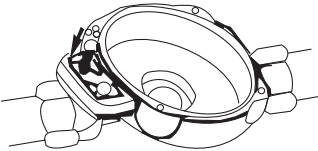
<p>Impurities and pump jam due to rust may affect the proper functioning of auto switch. In such cases, please follow the below given directions. Switching off the power is mandatory before repairing the auto switch.</p>	
<p>Cut off the power and close the isolating valves near by pump inlet and outlet ports. Twist off the two screws in terminal box, take out the switch assembly.</p>	
<p>Check and clean every sub-assembly of the auto switch.</p>	
<p>Check the flexibility of the auto switch valve.</p>	
<p>Install the valve in terminal box and cover with "O" ring. Fit the two screws and check for leakage, If no leakage is observed, then switch on the pump.</p>	

External Auto Switches



Connectors



Mounting Positions

This circulatory pump can be installed depending upon suitable field. But the Pump Shaft must be in Horizontal position.

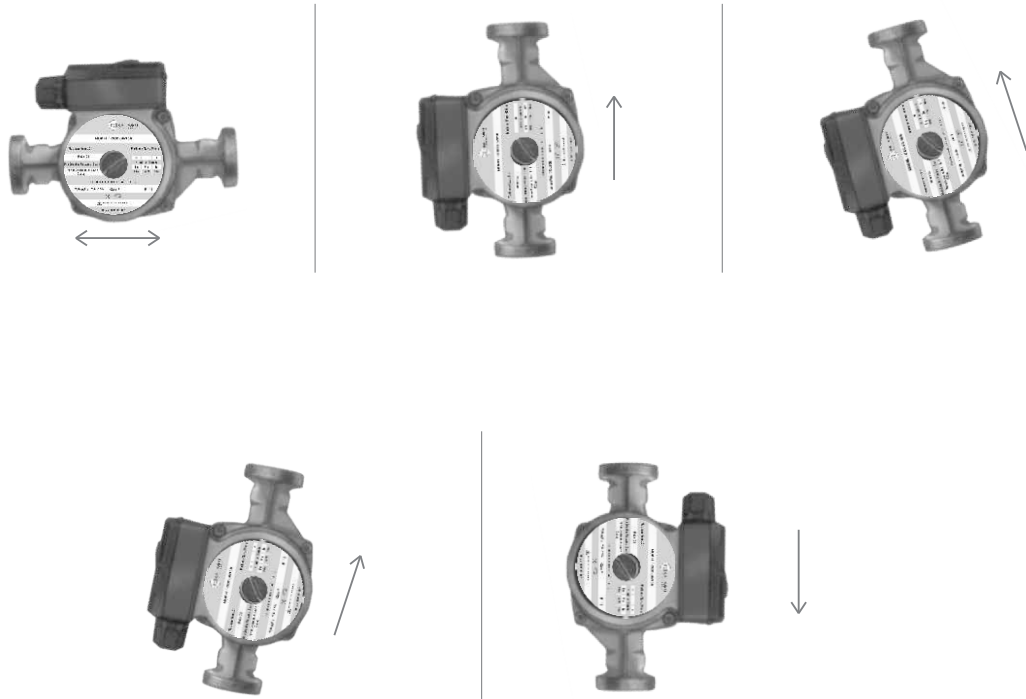

Filling & Venting of the System

Ensure the system is filled with the liquid pumped, through discharge valve and vented through the vent plug before starting. Before venting ensure the discharge valve is closed. Slacken & remove the vent plug carefully such that the escaping liquid doesn't cause any damage / injury. If it is hot then tighten the vent plug firmly.



Dimensional Drawing

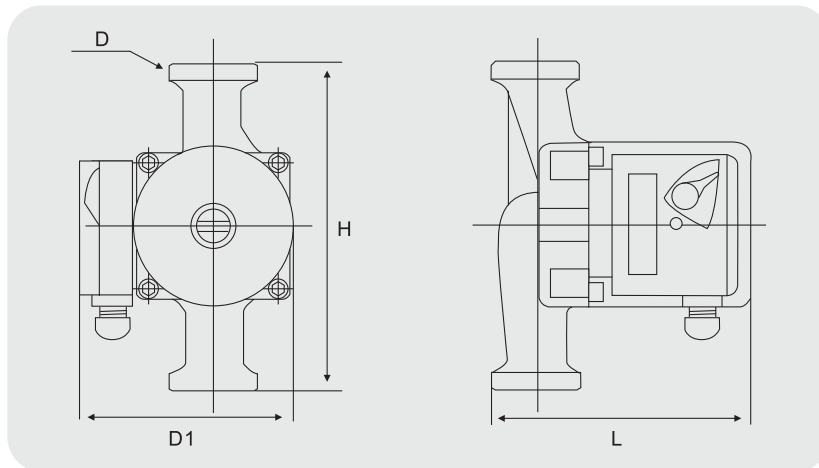

Dimensional Data

Pump Model	Height H (mm)	Connection Size (DN)	L (mm)	D	L (mm)
CCB 04-15A	130	15	132	1"	122
CCB 04-25A	130	25	129	1½"	123
CCB 04-25C	180	25	129	1½"	123
CCB 04-32C	180	32	129	2"	123
CCC 06-15A	130	15	132	1"	122
CCC 06-20A	130	20	129	1¼"	123
CCC 06-25B*	166	25	160	1½"	120
CCC 06-25A	130	25	129	1½"	123
CCC 06-25C	180	25	129	1½"	123
CCC 06-32C	180	32	129	2"	123
CCE 07-25C	180	25	145	1½"	126
CCE 07-32C	180	32	145	2"	126
CCG 08-15C	180	15	159	1"	135
CCG 08-25C	180	25	159	1½"	135
CCH 08-25C	180	25	153	1½"	138
CCG 11-20C	180	20	147	1"	141
CCI 12-20C	180	20	147	1"	147
CCI 12-25C	180	25	147	1½"	147
CCJ 14-25C	180	25	150	1½"	140
CCJ 08-32D	190	32	166	2"	147
CCJ 08-40E*	200	40	166	2"	147
CCK 11-32FS	225	32	210	2"	180
CCL 12-40GS*	225	40	300	2"	200
CCM 17-40GS*	250	40	300	2"	200
CCN 20-40GS*	250	40	300	2"	200

* Flange type connection.

Note : Pump models with last digit 'S' are of single (Standard) speed operation.

Performance Curves

Multi Speed (3 Level) Models



CCB 04-15A
Capacitor : 2.5µf

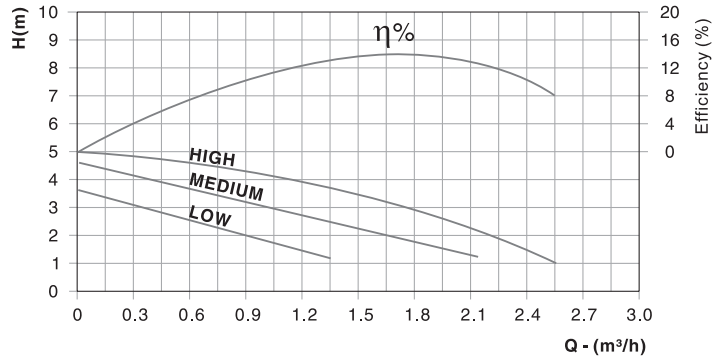

Pump Model	Speed	Power (W)	Amps (A)	Max. Head (m)	Max. Flow (m³/h)	Pipe Size	Port to Port	Inlet Outlet	Wt. (kg)
CCB 04-15A	H	72	0.33	4.5	2.5	15mm	130mm	1"	2.2
	M	53	0.24	4	2.1				
	L	38	0.17	3	1.4				



CCB 04-25A
Capacitor : 2.5µf

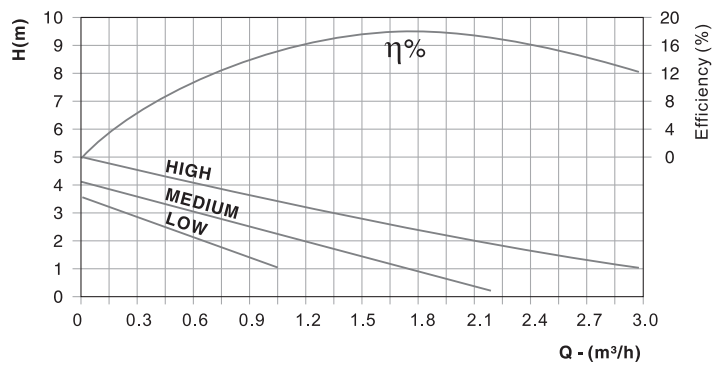

Pump Model	Speed	Power (W)	Amps (A)	Max. Head (m)	Max. Flow (m³/h)	Pipe Size	Port to Port	Inlet Outlet	Wt. (kg)
CCB 04-25A	H	72	0.33	4.5	2.9	25mm	130mm	1½"	2.4
	M	53	0.24	4	2.2				
	L	38	0.17	3	1.1				
CCB 04-25C	H	72	0.33	4.5	2.9	25mm	180mm	1½"	2.4
	M	53	0.24	4	2.2				
	L	38	0.17	3	1.1				



CCB 04-25C
Capacitor : 2.5µf

Performance Curves

Multi Speed (3 Level) Models



CCB 04-32C
Capacitor : 2.5µf

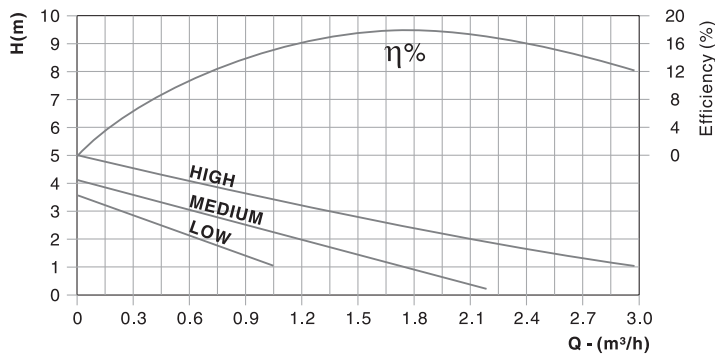

Pump Model	Speed	Power (W)	Amps (A)	Max. Head (m)	Max. Flow (m³/h)	Pipe Size	Port to Port	Inlet Outlet	Wt. (kg)
CCB 04-32C	H	72	0.33	4.5	2.9	32mm	180mm	2"	2.4
	M	53	0.24	4	2.2				
	L	38	0.17	3	1.1				



CCC 06-15A
Capacitor : 3µf

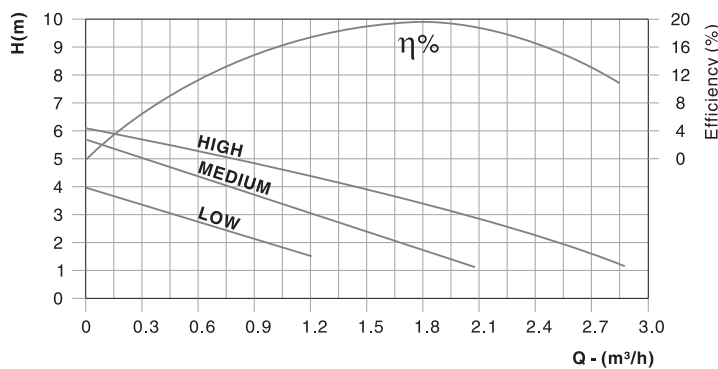

Pump Model	Speed	Power (W)	Amps (A)	Max. Head (m)	Max. Flow (m³/h)	Pipe Size	Port to Port	Inlet Outlet	Wt. (kg)
CCC 06-15A	H	93	0.42	6	2.9	15mm	130mm	1"	2.2
	M	67	0.3	5	2.1				
	L	46	0.21	3	1.2				

Performance Curves

Multi Speed (3 Level) Models



CCC 06-20A
Capacitor : 3µf

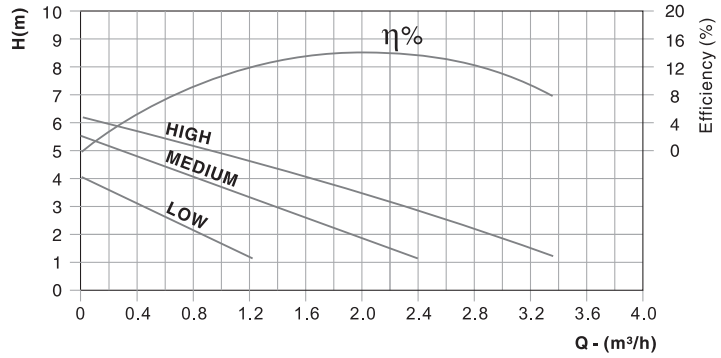

Pump Model	Speed	Power (W)	Amps (A)	Max. Head (m)	Max. Flow (m³/h)	Pipe Size	Port to Port	Inlet Outlet	Wt. (kg)
CCC 06-20A	H	93	0.42	6	3.3	20mm	130mm	1¼"	2.3
	M	67	0.3	5	2.3				
	L	46	0.21	3	1.3				



CCC 06-25B*
Capacitor : 3µf

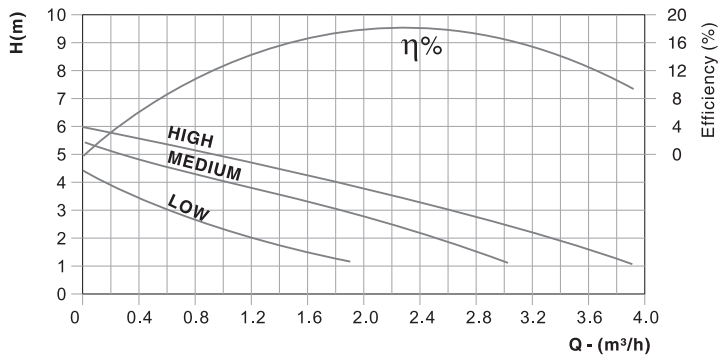

Pump Model	Speed	Power (W)	Amps (A)	Max. Head (m)	Max. Flow (m³/h)	Pipe Size	Port to Port	Inlet Outlet	Wt. (kg)
CCC 06-25B*	H	93	0.42	6	3.3	25mm	165mm	1½"	2.6
	M	67	0.3	5	2.3				
	L	46	0.21	3	1.3				

* Flange type connection.

Performance Curves

Multi Speed (3 Level) Models



CCC 06-25A
Capacitor : 3µf

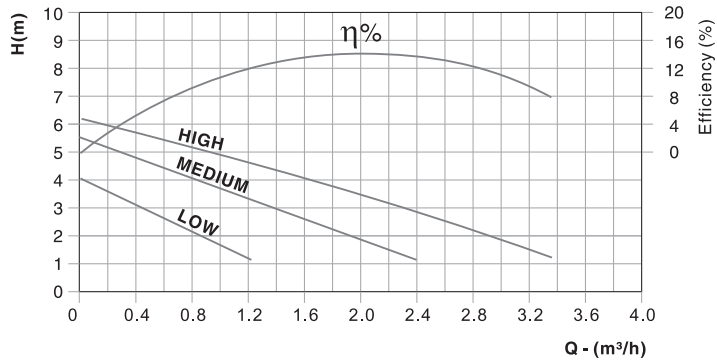

CCC 06-25C
Capacitor : 3µf

Pump Model	Speed	Power (W)	Amps (A)	Max. Head (m)	Max. Flow (m³/h)	Pipe Size	Port to Port	Inlet Outlet	Wt. (kg)
CCC 06-25A	H	93	0.42	6	3.3	25mm	130mm	1½"	2.4
	M	67	0.3	5	2.3				
	L	46	0.21	3	1.3				
CCB 06-25C	H	93	0.42	6	3.3	25mm	180mm	1½"	2.4
	M	67	0.3	5	2.3				
	L	46	0.21	3	1.3				



CCC 06-32C
Capacitor : 3µf

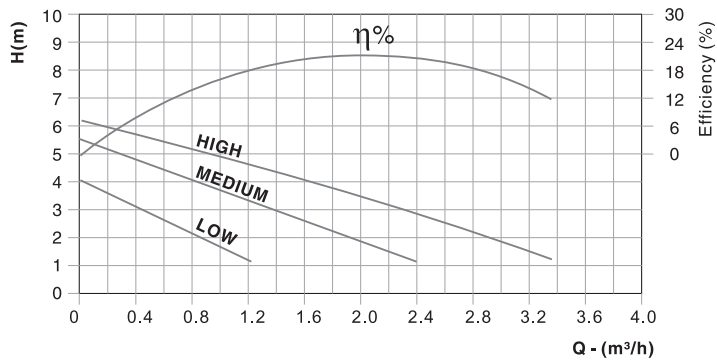

Pump Model	Speed	Power (W)	Amps (A)	Max. Head (m)	Max. Flow (m³/h)	Pipe Size	Port to Port	Inlet Outlet	Wt. (kg)
CCC 06-32C	H	93	0.42	6	3.3	32mm	180mm	2"	2.5
	M	67	0.3	5	2.3				
	L	46	0.21	3	1.3				

Performance Curves

Multi Speed (3 Level) Models



CCE 07-25C
Capacitor : 4µf

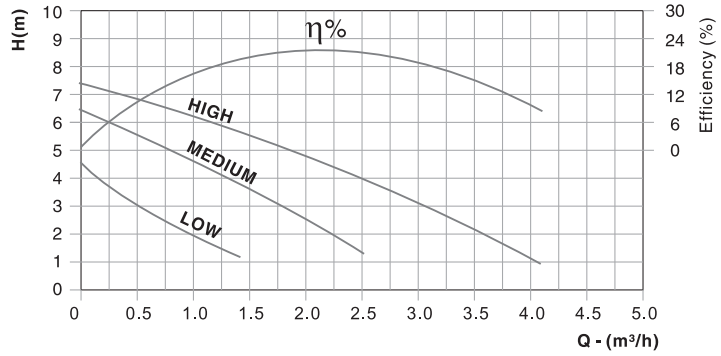

Pump Model	Speed	Power (W)	Amps (A)	Max. Head (m)	Max. Flow (m³/h)	Pipe Size	Port to Port	Inlet Outlet	Wt. (kg)
CCE 07-25C	H	135	0.61	7	3.9	25mm	180mm	1½"	2.5
	M	93	0.42	6.5	2.6				
	L	67	0.3	4.5	1.3				



CCE 07-32C
Capacitor : 4µf

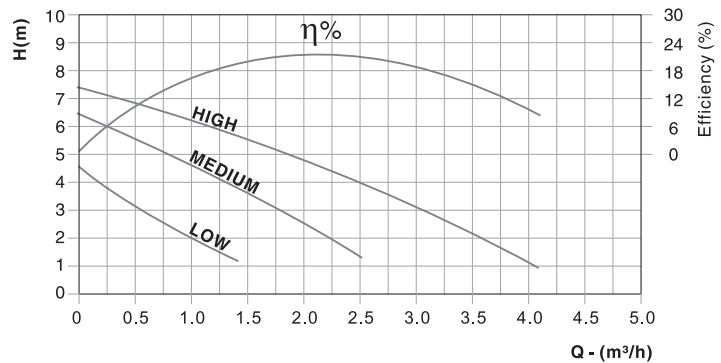

Pump Model	Speed	Power (W)	Amps (A)	Max. Head (m)	Max. Flow (m³/h)	Pipe Size	Port to Port	Inlet Outlet	Wt. (kg)
CCE 07-32C	H	135	0.61	7	3.9	32mm	180mm	2"	2.8
	M	93	0.42	6.5	2.6				
	L	67	0.3	4.5	1.3				

Performance Curves

Multi Speed (3 Level) Models



CCG 08-15C
Capacitor : 4µf

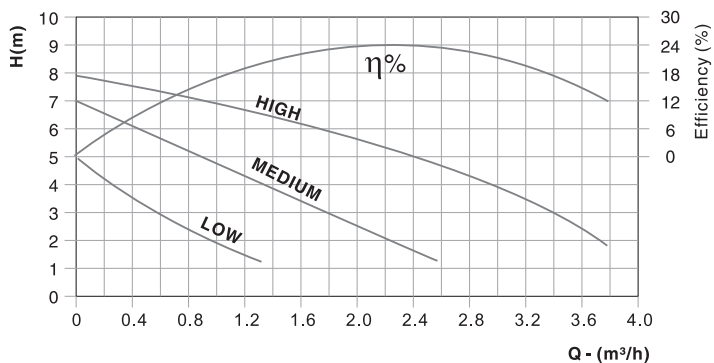

Pump Model	Speed	Power (W)	Amps (A)	Max. Head (m)	Max. Flow (m³/h)	Pipe Size	Port to Port	Inlet Outlet	Wt. (kg)
CCG 08-15C	H	165	0.75	8	3.9	15mm	180mm	1"	3.3
	M	115	0.52	7	2.5				
	L	75	0.34	5	1.3				



CCG 08-25C
Capacitor : 4µf

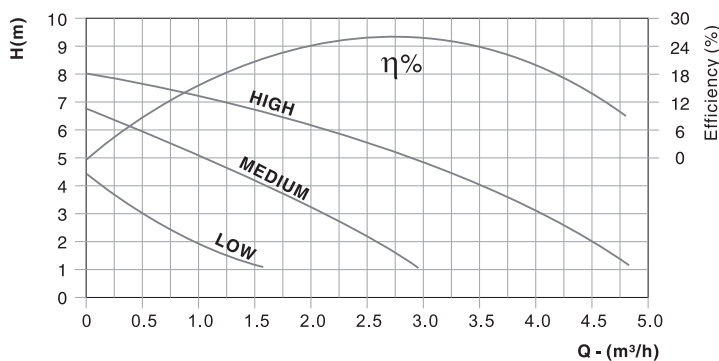

Pump Model	Speed	Power (W)	Amps (A)	Max. Head (m)	Max. Flow (m³/h)	Pipe Size	Port to Port	Inlet Outlet	Wt. (kg)
CCG 08-25C	H	165	0.61	8	4.8	25mm	180mm	1½"	3.4
	M	115	0.42	7	2.9				
	L	75	0.3	5	1.5				

Performance Curves

Multi Speed (3 Level) Models



CCH 08-25C
Capacitor : 6 μ f

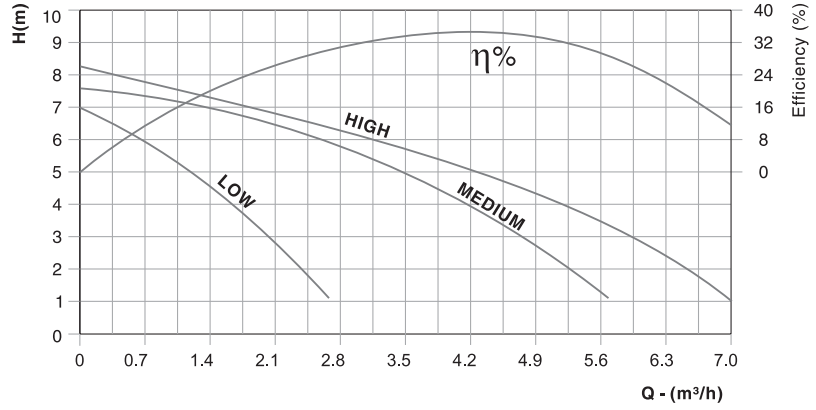

Pump Model	Speed	Power (W)	Amps (A)	Max. Head (m)	Max. Flow (m³/h)	Pipe Size	Port to Port	Inlet Outlet	Wt. (kg)
CCH 08-25C	H	182	0.83	8	6.9	25mm	180mm	1½"	3.8
	M	170	0.77	7.5	5.7				
	L	145	0.66	7	2.7				



CCG 11-20C
Capacitor : 4 μ f

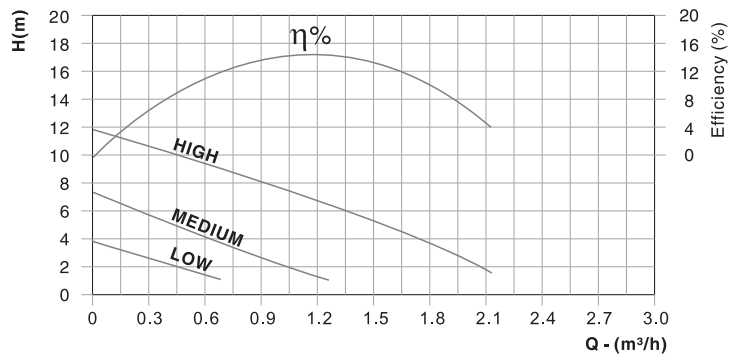

Pump Model	Speed	Power (W)	Amps (A)	Max. Head (m)	Max. Flow (m³/h)	Pipe Size	Port to Port	Inlet Outlet	Wt. (kg)
CCG 11-20C	H	165	0.75	11	2.1	20mm	180mm	1"	3.8
	M	115	0.52	7	1.2				
	L	75	0.34	3.4	0.6				

Performance Curves

Multi Speed (3 Level) Models



CCI 12-20C
Capacitor : 6µf

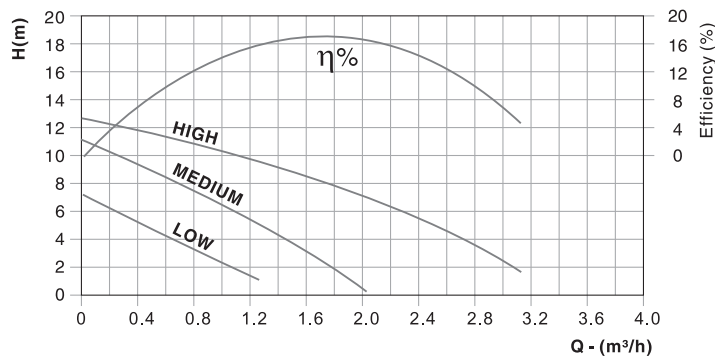

Pump Model	Speed	Power (W)	Amps (A)	Max. Head (m)	Max. Flow (m³/h)	Pipe Size	Port to Port	Inlet Outlet	Wt. (kg)
CCI 12-20C	H	245	1.11	12	3.1	20mm	180mm	1"	4.2
	M	220	1.0	11	1.9				
	L	145	0.66	7	1.3				



CCI 12-25C
Capacitor : 6µf

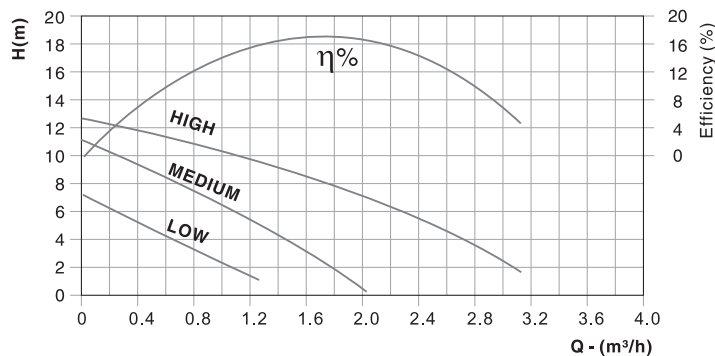

Pump Model	Speed	Power (W)	Amps (A)	Max. Head (m)	Max. Flow (m³/h)	Pipe Size	Port to Port	Inlet Outlet	Wt. (kg)
CCI 12-25C	H	245	1.11	12	3.1	25mm	180mm	1½"	4.5
	M	220	1.0	11	1.9				
	L	145	0.66	7	1.8				

Performance Curves

Multi Speed (3 Level) Models



CCJ 14-25C
Capacitor : 8µf

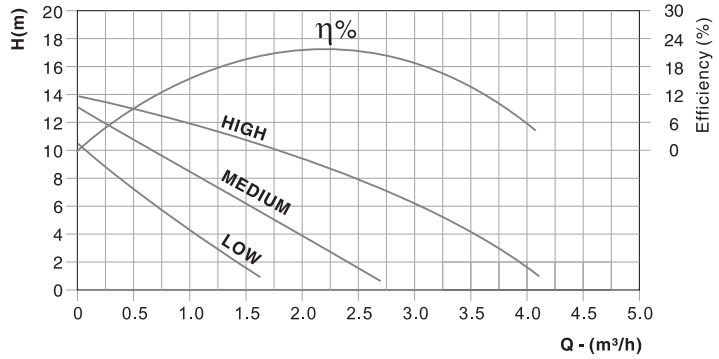

Pump Model	Speed	Power (W)	Amps (A)	Max. Head (m)	Max. Flow (m³/h)	Pipe Size	Port to Port	Inlet Outlet	Wt. (kg)
CCJ 14-25C	H	270	1.23	14	4.1	25mm	180mm	1½"	4.9
	M	210	0.95	13	2.8				
	L	150	0.68	10	1.7				



CCJ 08-32D
Capacitor : 8µf

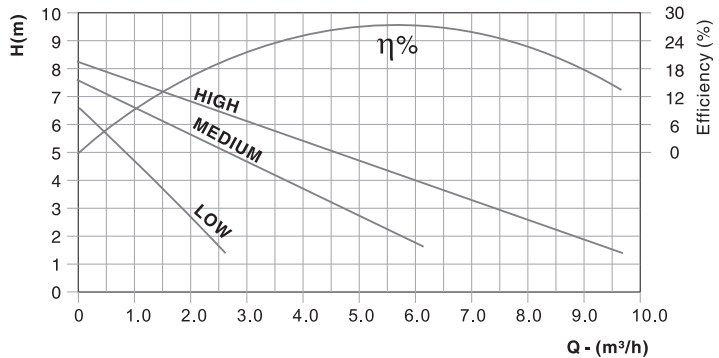

Pump Model	Speed	Power (W)	Amps (A)	Max. Head (m)	Max. Flow (m³/h)	Pipe Size	Port to Port	Inlet Outlet	Wt. (kg)
CCJ 08-32D	H	270	1.23	8	9.6	32mm	190mm	2"	5
	M	210	0.95	7.5	6.2				
	L	150	0.68	6.5	2.6				

Performance Curves

Multi Speed (3 Level) Model



CCJ 08-40E*
Capacitor : 8 μ f

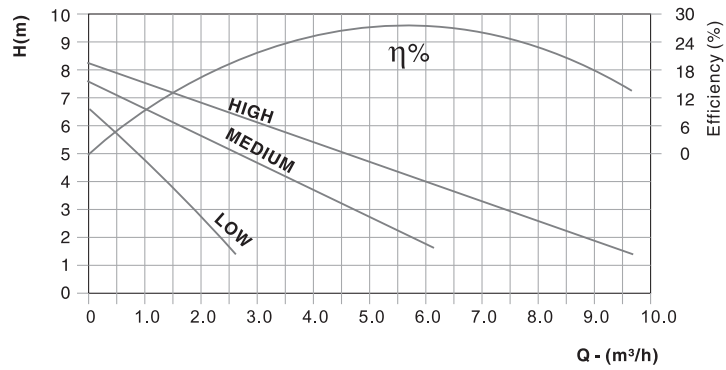

Pump Model	Speed	Power (W)	Amps (A)	Max. Head (m)	Max. Flow (m³/h)	Pipe Size	Port to Port	Inlet Outlet	Wt. (kg)
CCJ 08-40E*	H	270	1.23	8	9.6	40mm	200mm	2"	5.9
	M	220	0.95	7.5	6.2				
	L	150	0.68	6.5	2.6				

* Flange type connection.

Single Speed Model



CCK 11-32FS
Capacitor : 8 μ f

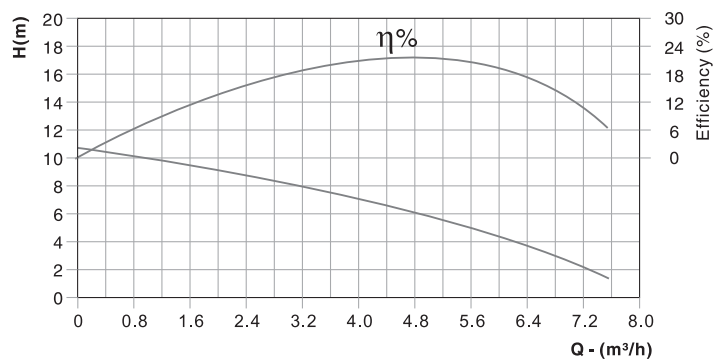

Pump Model	Power (W)	Amps (A)	Max. Head (m)	Max. Flow (m³/h)	Pipe Size	Port to Port	Inlet Outlet	Wt. (kg)
CCK 11-32FS	400	1.81	11	7.6	32mm	225mm	2"	7

Performance Curves

Single Speed Models



CCL 12-40GS*
Capacitor : 12µf

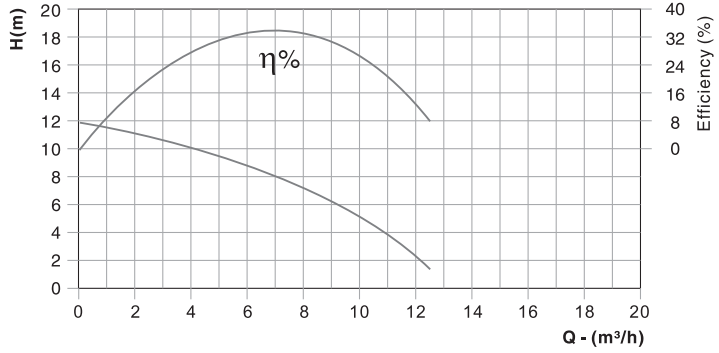

Pump Model	Power (W)	Amps (A)	Max. Head (m)	Max. Flow (m³/h)	Pipe Size	Port to Port	Inlet Outlet	Wt. (kg)
CCL 12-40GS*	550	2.5	12	12	40mm	225mm	2"	17

* Flange type connection.



CCM 17-40GS*
Capacitor : 15µf

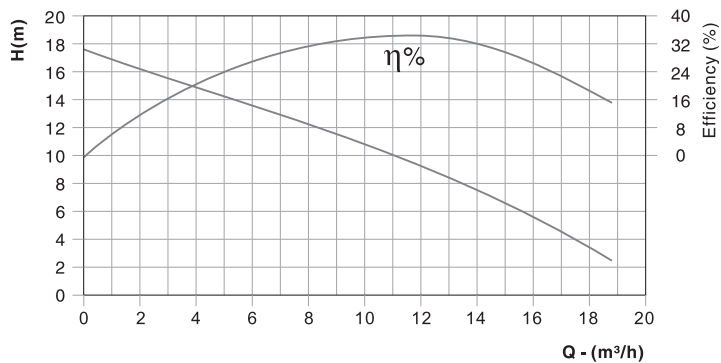

Pump Model	Power (W)	Amps (A)	Max. Head (m)	Max. Flow (m³/h)	Pipe Size	Port to Port	Inlet Outlet	Wt. (kg)
CCM 17-40GS*	750	3.4	17	18.6	40mm	250mm	2"	17

* Flange type connection.

Performance Curves

Single Speed Model



CCN 20-40GS*
Capacitor : 22 μ f

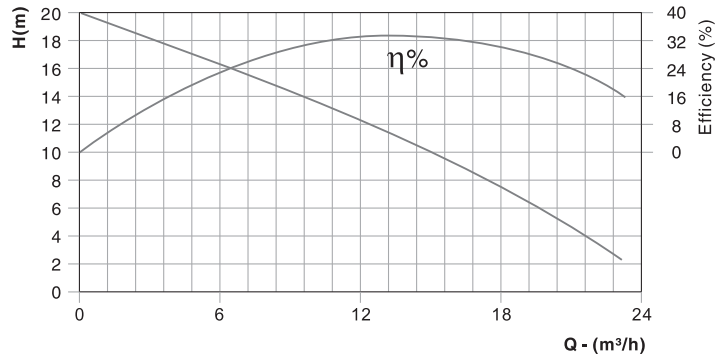

Pump Model	Power (W)	Amps (A)	Max. Head (m)	Max. Flow (m³/h)	Pipe Size	Port to Port	Inlet Outlet	Wt. (kg)
CCN 20-40GS*	1100	5	20	23.1	40mm	250mm	2"	19

* Flange type connection.

W I N N I N G W A Y S

When you have a good thing going it is quite in the fitting of things that recognitions come our way. Several prestigious awards, which decorate our shelf, say it all. These rewards not only acknowledge our position as a leader in the water pump industry but also serve as reminders about what the customer expects from a winner. And we, as ever, have our ears perfectly tuned to customer expectations.





C.R.I. PUMPS

Pumping trust. Worldwide.

Pumps

Pumps that come with high efficiency.

that

Pumps that ensure low power consumption.

bear

Pumps that are symbols of perfection.

the

Pumps that can serve you for a lifetime.

C.R.I.

Pumps that bear the C.R.I. seal.

seal.

C.R.I. PUMPS (PVT) LIMITED

(International Division)

7/46-1, Keeranatham Road, Saravanampatty, Coimbatore - 641 035. INDIA. Phone : +91-422-3911610, 3911612
Fax : +91-422-3911600 e-mail : cri@criexports.com website: www.cripumps.com

C.R.I. PUMPS S.A. (PTY) LIMITED

P.O. Box 6292, Halfway House, Midrand - 1685, Johannesburg,
South Africa. Tel : +27-11-8058631 / 32 , Fax : +27-11-8058630
e-mail : cri@cripumps.co.za website : www.cripumps.com

Branches : Pietermaritzburg, Tel : +27-33-3453944
Capetown, Tel : +27-21-9312516

C.R.I. POMPA SANAYİ VE TİCARET LİMİTED ŞİRKETİ

10032 Sk. No:12 A.O.S.B. 35620 Çiğli-İzmir-Türkiye.
Tel : +90-232-328 22 99, Fax : +90-232-328 23 33
E-mail : cri@cripompa.com Website : www.cripompa.com

C.R.I. BOMBAS HIDRÁULICAS LTDA

Av. Rodrigo Fernando Grillo, 457, Jd. Manacas,
CEP - 14.801-534, Araraquara - SP, Brasil.
Fone : +55-16-3331 1099, Fax : +55-16-3331 5344
e-mail : cri@cribombas.com.br website : www.cribombas.com.br
Filial : Jaboatão dos Guararapes - PE, Fone : +55-81-3093 9600

C.R.I. PUMPS (FZE)

P.O. Box 7988, A4-40 SAIF-Zone, Sharjah, U.A.E.
Tel : +971-6-5573041 (3 Lines),
Fax : +971-6-5573042
e-mail : cripumps@eim.ae

BOMBAS C.R.I. ESPAÑA, S.L.,

Poligono Industrial El.Bony Calle 31, No.137, 46470 Catarroja(Valencia) Spain.
Tel: +34-96 1842 974 Fax: +34-96 1842 977
Email: cri@bombascri.es Website: www.bombascri.es



* For Specific Models Only.